

# Smart Lifestyle Australia Single Phase ESS User Manual

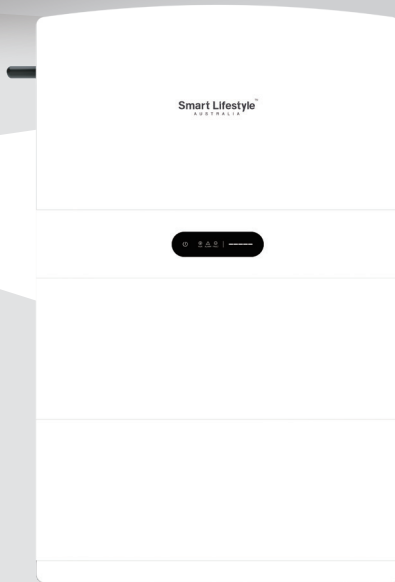



## EXCLUSION OF LIABILITY

All names, trademarks, product names or other designations used in this manual are legally protected even if "they are" not indicated such as (e.g., as a trademark). **Smart Lifestyle Australia Pty Ltd.** assumes no liability or warranty for their free usage. The illustrations and texts have been compiled with great care. However, the possibility of errors cannot be ruled out. The compilation is made without any guarantee. But the data in this manual are reviewed regularly and any necessary corrections are included in subsequent editions.

## GENERAL NOTE ON GENDER EQUALITY

Smart Lifestyle Australia Pty Ltd. is aware of the importance of language with regard to the equality of women and men and always makes an effort to reflect this in the documentation. Nevertheless, for the sake of readability we are unable to use non-gender-specific terms throughout and use the masculine form instead.

© 2023 Smart Lifestyle Australia Pty Ltd.

All rights reserved by Smart Lifestyle Australia Pty Ltd. including those of reproduction by photocopy and storage in electronic media. Commercial use or distribution of the texts, displayed models, diagrams and photographs appearing in this product is not permitted. This manual may not be reproduced, stored, transmitted or translated in any form or by means of any medium, in whole or in part, without written permission.

# CONTENTS

<b>1 Notes on this Manual</b> .....	01
1.1 Scope of Validity.....	01
1.2 Target Group.....	02
1.3 Symbols Used.....	03
1.4 Eu Declarations of Conformity.....	03
<b>2 Safety</b> .....	04
2.1 Explanation of Symbols.....	04
2.2 Important Safety Instructions.....	05
2.3 Handle Heavy Loads Safely.....	11
<b>3 Introduction</b> .....	12
3.1 Basic Features.....	12
3.2 Working Mode.....	13
3.3 Packing List.....	14
3.4 System Appearance.....	15
3.5 System Individual Modules Introduction.....	15
3.5.1 Inverter.....	15
3.5.2 BMS Control Box.....	18
3.5.3 Battery Pack.....	20
3.5.4 Base.....	21
3.6 LED Lights Display Description.....	22
3.6.1 Battery System LED Display Description.....	22
3.6.2 Inverter LED Indications.....	25
<b>4 Installation</b> .....	26
4.1 Check for Physical Damage.....	26
4.2 Equipment Installation.....	26
4.2.1 Requirements.....	27
4.2.2 Required for Installation.....	28
4.3 Installation Process.....	29
4.3.1 Battery Pack Installation.....	29
4.3.2 Inverter Installation.....	32
<b>5 Electrical Connection</b> .....	33
5.1 Battery System Cable Connection.....	33
5.2 PV Connection.....	34
5.3 AC Input/Output Connection.....	36
5.4 Communication Interface Connection.....	40
5.4.1 PM (METER/CT) Interfaces.....	40
5.4.2 DRM Port Connections (Optional).....	42
5.4.3 COM/LCD Interface.....	43
5.4.4 PARALLEL (INV) Interface.....	43
5.5 External Smart Meter (optional) Connection.....	43



5.6 Earth Fault Alarm Connection .....	44
5.7 Wiring Diagram .....	45
5.8 Battery Pack Capacity Expansion .....	46
<b>6 System Operation .....</b>	<b>47</b>
6.1 Power on the System .....	47
6.2 Switch Off .....	48
<b>7 Plant Monitoring .....</b>	<b>48</b>
7.1 Create a Plant .....	48
7.2 Add a Logger .....	50
7.3 Network Configuration .....	52
<b>8 APP Data View .....</b>	<b>55</b>
8.1 Real Time Data .....	55
8.2 Statistics Data .....	56
8.3 Device Info .....	56
8.4 Alert Data .....	57
<b>9 Remote Setup for Installers .....</b>	<b>58</b>
9.1 Regional Grid Standard .....	58
9.2 Grid Protection Value and Power Quality Response .....	59
9.3 Advanced Function .....	60
<b>10 Maintenance .....</b>	<b>62</b>
10.1 Maintenance Before Operation .....	62
10.2 Maintenance During Operation .....	63
<b>11 Troubleshooting .....</b>	<b>64</b>
11.1 System Fault Information table .....	64
11.2 Inverter Fault Information .....	65
<b>12 Packaging, Transportation, Storage .....</b>	<b>69</b>
Annex 1: Inverter Parameter Table .....	70
Annex 2: Battery Parameters .....	73
Annex 3: System Parameter .....	73

# 1 Notes on this Manual

## 1.1 Scope of Validity

This manual is an integral part of SLA series single phase residential energy storage system with hybrid inverter, it describes the assembly, installation, commissioning, maintenance and failure of the product. Please read it carefully before operating.

### Configuration

Inverter	SLA-HB-S1-3.8kW1P
	SLA-HB-S1-5kW1P
	SLA-HB-S1-6kW1P
ESS	SLA-ESS-S1-5kWh
	SLA-ESS-S1-10kWh
	SLA-ESS-S1-15kWh
	SLA-ESS-S1-20kWh
	SLA-ESS-S1-30kWh
System Configuration	SLA-BESS-S1-I3.8B5
	SLA-BESS-S1-I5B10
	SLA-BESS-S1-I5B15
	SLA-BESS-S1-I5B20
	SLA-BESS-S1-I5B30

Inverter naming rules, for example:SLA-HB-S1-5kW1P

"SLA" stands for "Smart Lifestyle Australia".

"HB" stands for "Hybrid Inverter".

"S1" stands for "Product series 1 from SLA".

"5kW1P" stands for "rated output power "Inverter rated power for 1 phase".

ESS naming rules, for example: SLA-ESS-S1-5kWh

"SLA" stands for "Smart Lifestyle Australia".

"ESS" stands for "Energy Storage System"

"S1" stands for "Product series 1 from SLA"

"5kWh" stands for "Battery storage capacity"

Store this manual where it will be accessible at all times.

System Parameter naming rules, for example: SLA-BESS-S1-I5B10

"SLA" stands for "Smart Lifestyle Australia".

"BESS" stands for "Battery Energy Storage System"

"S1" stands for "Product series 1 from SLA"

"I5" stands for "Inverter power 5kW"

"B10" stands for "Battery capacity 10kWh"

## 1.2 Target Group

This manual is for qualified electricians. The tasks described in this manual only can be performed by qualified electricians.

### 1.3 Symbols Used

The safety instructions and general information appear in this document as described below:



**Danger!**

Indicates a hazard with a high level of risk which, if not avoided, will result in death or serious injury.



**Warning!**

Indicates a hazard with a medium level of risk which, if not avoided, could result in death or serious injury.



**Caution**

Indicates a hazard with a low level of risk which, if not avoided, could result in minor or moderate injury.



**Notice**

Indicates actions of which, if not avoided, could result in material damage.

---

### 1.4 Eu Declarations of Conformity

Smart Lifestyle Australia Pty Ltd. hereby declares that the inverter described in this document complies with the basic requirements and other relevant conditions of the directives listed below.

Directive 2014/30/EU

(On the approximation of the laws of the Member States relating to electromagnetic compatibility (EMC))

Directive 2014/35/EU

(On the harmonization of the laws of the Member States relating to the making available on the market of electrical equipment designed for use within certain voltage limits – in short: Low Voltage Directive)









Directive 2011/65/EU (RoHS)

(on the restriction of the use of certain hazardous substances in electrical and electronic equipment.)

## 2 Safety

### 2.1 Explanation of Symbols

This section gives an explanation of all the symbols shown on the inverter and on the type label.

Symbol	Explanation
	CE mark. The inverter complies with the requirements of the applicable CE
	TUV mark
	Beware of hot surface. The inverter can become hot during operation. Avoid contact during operation. Danger of high temperature.
	Danger to life due to high voltage in the inverter!
	Danger Risk of electric shock!
	Observe enclosed documentation
	The system can't be disposed together with the household waste. Disposal information can be found in the enclosed documentation.
	Do not dispose of the battery system together with the household waste but in accordance with the disposal regulations for electronic waste applicable at the installation site.
	Do not operate this equipment until it is isolated from battery, grid and on-site PV generator.



Danger to life due to high voltage.

There is residual voltage existing in the inverter after powering off, which needs 5 min to discharge.

Wait 5 minutes before opening the cover.

---

## 2.2 Important Safety Instructions

---



**Danger!**

Danger!

Danger to life due to high voltage in the inverter! All work must be carried out by qualified electrician

The appliance should not be used by children or individuals with limited physical sensory or mental abilities, or lack of experience and knowledge, unless they have received supervision or instruction.

---



**Caution**

Caution!

Possible damage to health as result of the radiation!

Do not stay closer than 20cm to inverter for any period of time.

---



**Notice**

Notice!

Grounding the PV generator.

Should comply with local requirements for grounding the PV modules and PV generator. It is recommended that the PV frame and other electrically conductive surfaces must be connected in a manner that provides continuous conduction and grounding for optimum system and personnel protection.

---



**Warning!**

Warning!

Ensure that input DC voltage  $\leq$  Max. DC voltage. Over voltage may cause permanent damage to inverter or other losses, which will not be included in warranty!

---

**Warning!**

Warning!  
Risk of electric shock!

---

**Warning!**

Warning!  
Authorized service personnel must disconnect both AC and DC power from inverter before attempting any maintenance or cleaning or working on any circuits connected to inverter.

---

**Warning!**

Warning!  
Do not operate the inverter when the device is running.

---

- Prior to the application, please read this section carefully to ensure correct and safe application. Please read the user manual properly.
- Original accessories are recommended here, otherwise may result in a risk of fire, electric shock, or injury to person.
- Ensure that the wiring is in good condition and is not smaller than the required size.
- Do not disassemble any parts of inverter which are not mentioned in installation guide. Please visit warranty before after-sales services. Disassembling the inverter by yourself, may result in a risk of electric shock or fire and will void your warranty.
- Keep away system from flammable, explosive materials to avoid fire accident.

- The installation place should be non-humid and non-corrosive.
- Authorized service personnel must use insulated tools when installing or working with this equipment.
- PV modules shall have an IEC 61730 class A rating.
- Never touch either the positive or negative pole of PV connecting device. Touching both of them at the same time is strictly prohibited.
- Even after the grid, battery, and PV supply are disconnected, the capacitors in the equipment may still hold a high voltage charge.
- Risky voltage will present for up to 5 minutes after disconnection from power supply
- CAUTION-RISK of electric shock from energy stored in capacitor, never operate on the inverter couplers, the grid cables, battery cables, PV cables or the PV generator when power is applied. After switching off the PV, battery and grid supply, always wait for 5minutes to let the intermediate circuit capacitors discharge before unplug DC, battery plug and grid coupler/port.
- When accessing the internal circuit of inverter, it is strictly advice wait for 5 minutes before operating the power circuit or demounting the electrolyte capacitors inside the device. Do not open the device earlier since the capacitors require time to discharge completely.



- Measure the voltage between terminals DC+ and DC- with a multi-meter (impedance at least 1Mohm) to ensure that the device is discharged before starting work (35VDC) inside the device.
- Testing to AS/NZS 4777.2:2020 to multiple inverter combinations has not been conducted So multiple phase inverter combinations should not be used or external devices should be used in accordance with the requirements of AS/NZS 4777.1.

### Anti-Islanding Effect

- Islanding effect is a special phenomenon in which grid-connected PV system still supply power to the distributed grid even the the grid supply fails or is outage for maintenance. It is dangerous for maintenance personnel and the public. Smart Lifestyle Australia series inverter provide Active Frequency Drift (AFD) to prevent islanding effect.

### RCD Breaker Installation

- The authorized installer needs to install RCD (rated fault current  $I_m \leq 240\text{mA}$ ) protection at Ac out port to ensure the current leakage protection.



#### Warning!

Warning!

High leakage current!

Grounding is essential before powering on the system.

---

- Incorrect grounding can cause physical injury, death or equipment malfunction.
- Make sure that grounding wire size is according to local safety regulations.
- Do not connect the ground terminals of the unit in series in case of a multiple installation. This product can cause current with a DC component, where a residual current operated protective (RCD) or monitoring (RCM) device is used for protection in case of direct or indirect contact, only an RCD or RCM of type B is allowed on the supply side of this product.

#### **For Australia and New Zealand**

- Electrical installation and maintenance shall be conducted by licensed electrician and shall comply with Australia National Wiring Rules.

#### **Battery Safety Instructions**

- Smart Lifestyle Australia series inverter should be worked with high voltage battery, for the specific parameters such as battery type, nominal voltage and nominal capacity etc., please refer to the parameters list.
- As battery modules may contain potential electric shock and short-circuit current danger, to avoid accidents, the following warnings should be observed during battery replacement:

1. Do not wear watches, rings or similar metallic items.
2. Use insulated tools.
3. Put on rubber shoes and gloves.
4. Do not place metallic tools and similar metallic parts on the batteries.
5. Switch off load connected to the batteries before dismantling battery connection terminals.
6. Licensed electrician with proper expertise can carry out the maintenance of battery modules.

**Notice**

The system detects a thermal runaway (Venting of gaseous electrolyte; Burning of the cell, spark formation and ignition of vented gas mixtures; Explosion of the cell) , it wirelessly sends a thermal runaway signal to the user's alarm system to inform the user that a thermal runaway has occurred. Users need to configure buzzer alarm products at home. (The alarm light is red, and the alarm buzzer has a sound level greater than 85dB but less than 110dB, with a frequency below 3.5kHz.)

## 2.3 Handle Heavy Loads Safely

- When carrying heavy objects, you should be prepared to avoid back pain or any kind of injury by heavy objects.

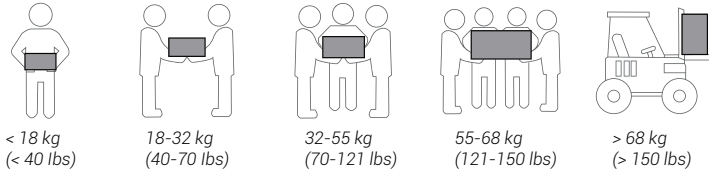

- When multiple people carry heavy objects at the same time, it is necessary to consider the height and other conditions, and do a reasonable job of personnel matching and division of labor to ensure a balanced weight distribution.
- When two or more people are carrying heavy loads together, one person should direct the equipment and lift or lower the equipment at the same time to ensure a uniform pace.
- When handling equipment by hand, you should wear protective gloves, labor protection shoes and other safety protective equipment to avoid injury.
- When carrying the equipment by hand, first approach the object, squat down, use the force of straightening your legs, do not use the strength of your back, slowly and steadily lift the object, and it is strictly forbidden to suddenly jerk or twist the body.
- Do not quickly lift heavy objects to waist height, but place them on a half-waist high workbench or an appropriate place, adjust the position of your palms, and then lift them.
- Carrying heavy objects must be balanced and stable; The speed of movement should be uniform and low; Positioning is required to be smooth and slow, in order to avoid any impact or drop that scratches the surface of the equipment or damages the components and cables of the equipment.

## 3 Introduction

### 3.1 Basic Features

Smart Lifestyle Australia Series is a high-quality Residential energy storage system (RESS) which can convert solar energy to AC energy and. It's an all-in-one RESS solution with the built-in LFP(Lithi-um-ion) battery and currently is not compatible with third party battery modules(including other LFPbattery and Lead acid battery)

The Smart Lifestyle Australia Series RESS can store energy in the batteries for future use or feed to public grid. Work mode depends on PV energy and user's preference. PV and store energy can be used in case of emergency or when the electricity rates are high.

#### System Diagram

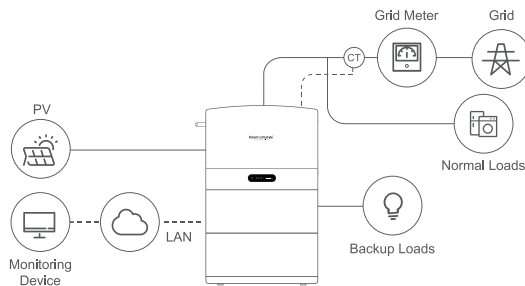

Figure1 DC-coupled Storage System – Scheme

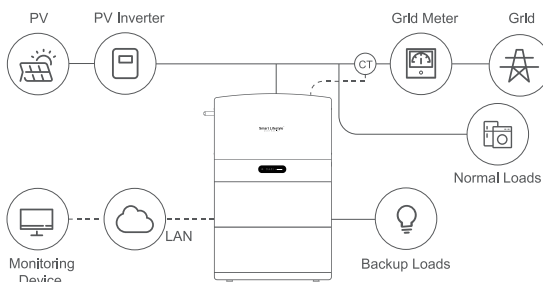

Figure 2 AC-coupled Storage System – Scheme

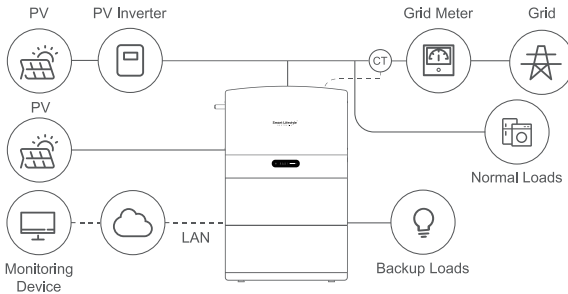

Figure 3 Hybrid-coupled Storage System – Scheme

### 3.2 Work Modes

There are three basic working modes that the end users can choose through inverter APP.

• **Self Use:**

The energy generated by the solar panels will be utilized in the following order: supply to the backup load; charge the battery and then, feed into the grid. When the sunset, the the backup load will be supported by the battery modules. If the power supply from the batteries is not sufficient, the grid will support the backup load demand.

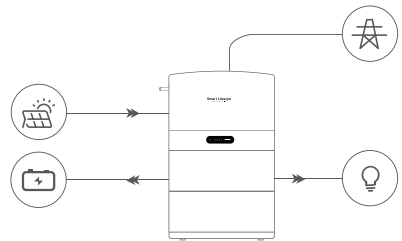

• **Back up:**

Under this mode, the battery is only used as a backup power supply when the grid fails, as long as the grid works, the batteries won't be used to power the loads. The battery will get charged with the power generated by the PV system or from the grid.

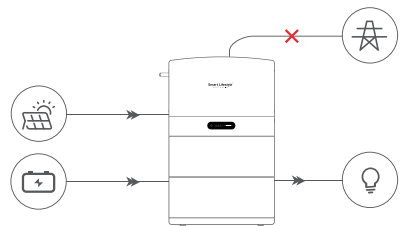

• **Peak shaving:**



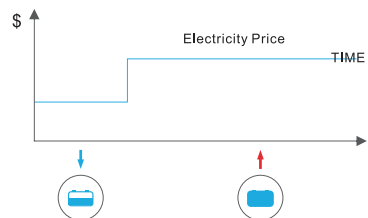





In this Mode the customer can set up the charging/discharging time & power of the batteries via APP.

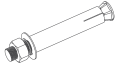
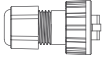
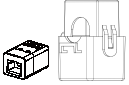
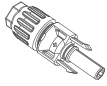

### 3.3 Packing List

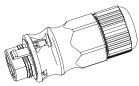
Check the following parts list to ensure it is complete.

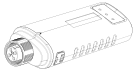
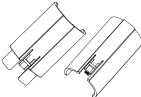
We deliver the whole system separately on site to client, this consists of:

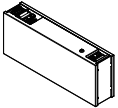
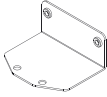
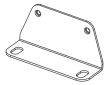
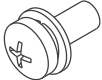
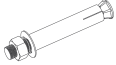
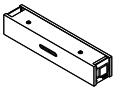
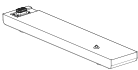
Inverter packing list				
				
1x Hybrid inverter	4xM6*12	4xM8*60	4x RJ45 cable end	1xCT(With RJ45 Adapter)
				
2x PV positive terminal	2x PV negative terminal	1x Grid male connector	1x Load female connector	2x Inverter bracket
				
Connecting wiring harness	Wi-Fi dongle	Unlocking Tools	1x Grounding Wire	
2x Battery packing list				
				
battery pack	2 PCS	2 PCS	M 5 *14(8 PCS)	M 8 *60(4 PCS)
Control box & base				
				
1xBMS control box	1x base			

### 3.4 System Appearance

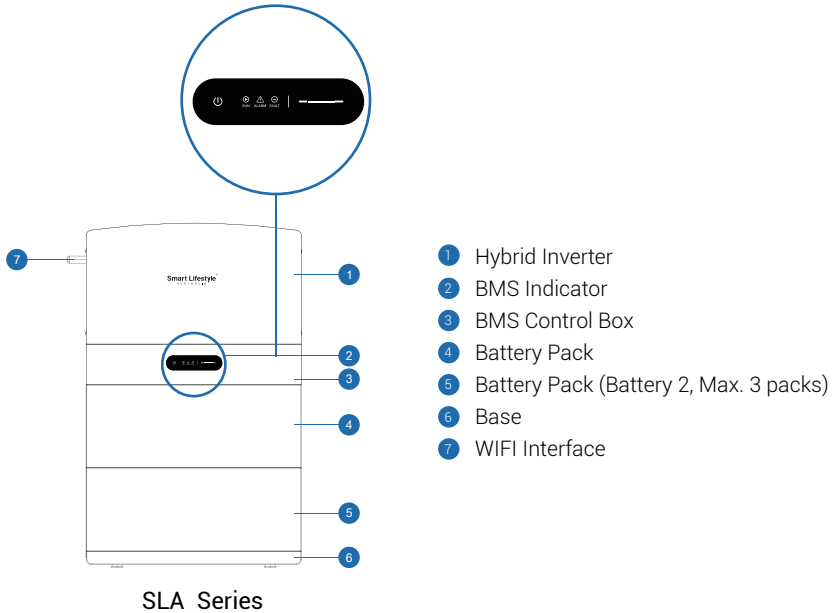

### 3.5 System Individual Modules Introduction

#### 3.5.1 Inverter

The inverter is a high-voltage component and has been sealed by the manufacturer. The inverter may only be replaced as a complete item and may not be opened. The inverter is located just underneath the cover plate. It comprises the inverter tray, which is fitted with a fan, and the following components:

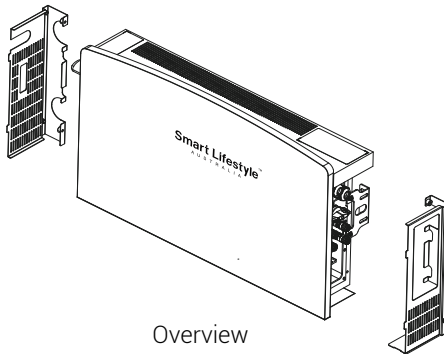



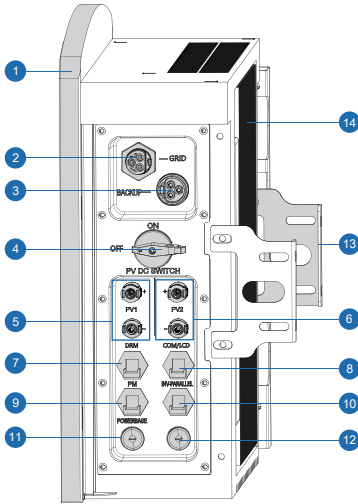

PCS right view

- 1 PCS front panel
- 2 Grid Interface
- 3 Backup Interface
- 4 PV DC SWITCH
- 5 PV1 Input Terminals
- 6 PV2 Input Terminals
- 7 DRM Interface
- 8 COM/LCD
- 9 PM (Meter/CT)
- 10 INV-PARALLEL Connection Port
- 11 POWERBASE Terminal
- 12 Spare Hole
- 13 Installation Bracket
- 14 Heat Sink

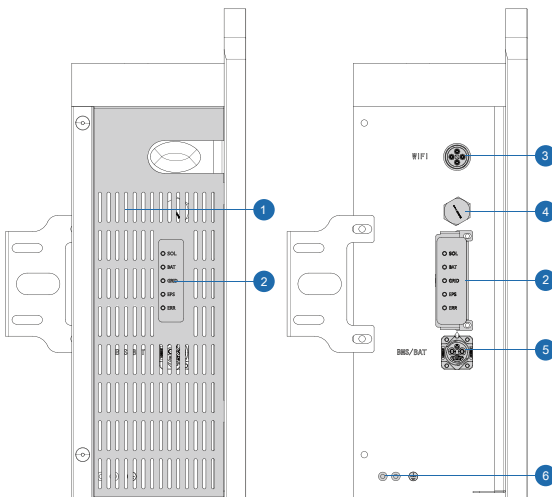

- 1 Hoods Cover
- 2 PCS Indicators
- 3 WIFI Interface
- 4 Pressure Relief Valve
- 5 BMS/BAT Interface
- 6 Grounding Ports

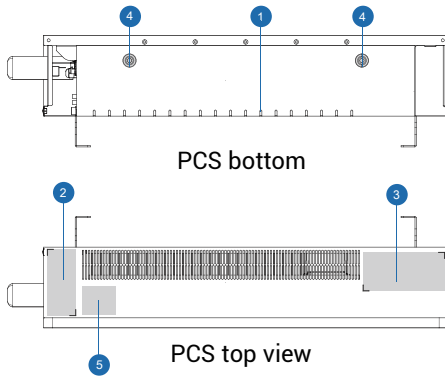

- ① Water Leakage Holes
- ② Warning Label Sticking Positions
- ③ Nameplate Sticking Position
- ④ Position Detector (female)
- ⑤ Service & Warranty Related Queries label Sticking Positions

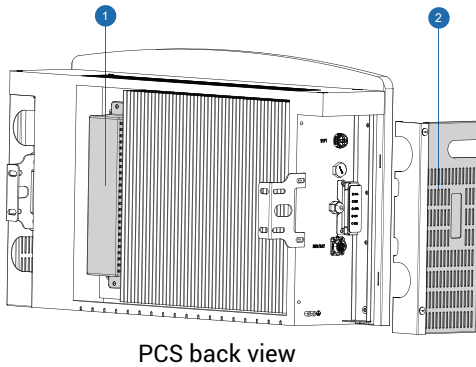

- ① Inductor box
- ② Hood Covers

This high-quality inverter is capable of AC/DC conversion according to the usage or requirement of different users, and intelligently realizes on-demand scheduling of energy between PV, battery, grid and load. Meanwhile, it has self-protection functions such as over-voltage, over-heat, over-current, etc., which improve the reliability of system operation; GFCI PV insulation impedance, and RCD device detects leakage faults of the system in real time, which improves the safety of system operation; and it meets the user's all-round demand for the home storage system in terms of safety, reliability, and intelligence to the maximum extent.

**PCS WIFI Interface:** The WIFI interface of the PCS is a port to operate and monitor the PCS or system through the Internet

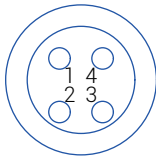
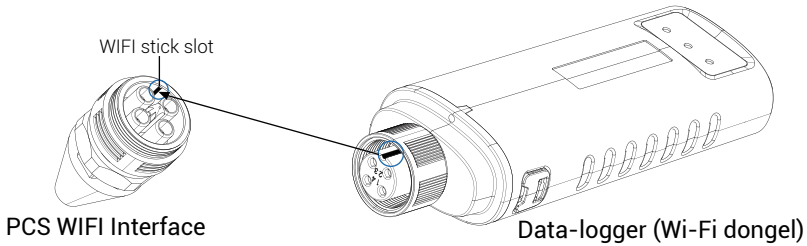

Pin	Network Name
1	VCC
2	GND
3	RS485-A
4	RS485-B

**Note:**

The WIFI stick slot has to be aligned to work properly

### 3.5.2 BMS Control Box

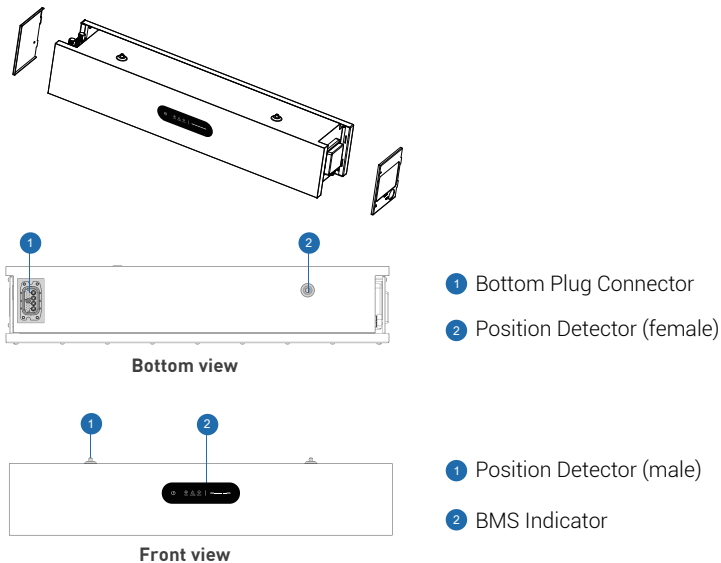



Top view

- 1 Position Detector (male)

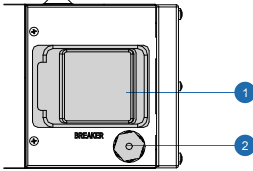

Right view

- 1 BAT Breaker
- 2 Debug

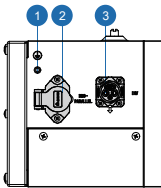

Left view (Opened cover)

- 1 Grounding Bolt (go to PCS)
- 2 BMS-PARALLEL Connection Port
- 3 INV Port

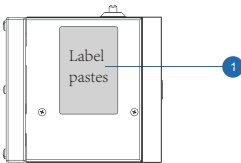

Left view

- 1 Identification Plate Sticking Position

The BMS module of residential energy storage system, also called battery management system, is used to control and monitor the charging and discharging process of the battery pack, to ensure the safety and lifetime of the battery pack. Its main functions include:

**Battery status monitoring:** monitor the parameters of the battery pack such as voltage, current, temperature, and the status of the battery pack, such as charging status, discharging status, and capacity.

**Charge control:** control the charging process of the battery pack, including charging current, charging voltage, charging time and other parameters to ensure the safety and charging efficiency of the battery pack.

**Discharge control:** control the discharge process of the battery pack, including discharge current, discharge voltage, discharge time and other parameters to ensure the safety and discharge efficiency of the battery pack.

**INV Port:** This interface is used to add more battery packs, which can transmit current, electricity phase and other parameters.

**BMS parallel connection port:** The PARALLEL port of the BMS control box is used to connect two battery clusters in parallel and to transmit power and communication signals.

**Power button:** Power button is used to wake up the separate them the battery is over discharged to power-down protection point.

### 3.5.3 Battery Pack



Battery bottom view

- 1 Bottom Connector
- 2 Position Detector (female)

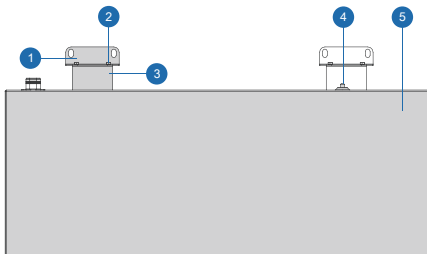

Battery front view

- 1 Mounting Piece 2
- 2 Connecting Screw
- 3 Mounting Piece 1
- 4 Position Detector (male)
- 5 Front Panel

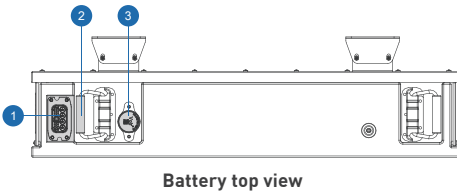

- 1 Battery Connection Port
- 2 Carrying handle
- 3 Explosion Proof Pressure Relief Valve

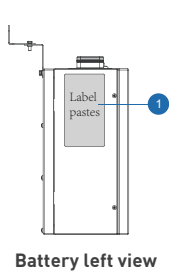

Battery left view

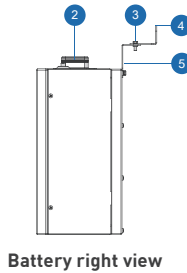

Battery right view

- 1 Label Paste Position
- 2 Bottom Connector
- 3 Connecting Screw
- 4 Mounting Piece 2
- 5 Mounting Piece 1

The battery pack of residential energy storage system is consisting of multiple battery cells. Its main functions include:

**Storing electrical energy:** the battery pack can store electrical energy from the grid or the **PV power supply:** The battery pack can supply electricity to a house or building by outputting stored power when the grid or PV cannot provide electricity.

**Monitoring:** The battery pack can monitor the status of the battery cells, such as voltage of charge and discharge, temperature, etc., to ensure their safety and reliability.

The battery pack usually need to be used in conjunction with other equipment, such as inverter and BMS control box, to achieve its full function.

### 3.5.4 Base

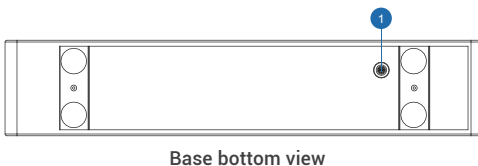

Base bottom view

- 1 Position Detector (male)

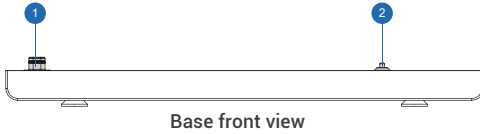

- ① Connection Port for Battery
- ② Position Detector (male)

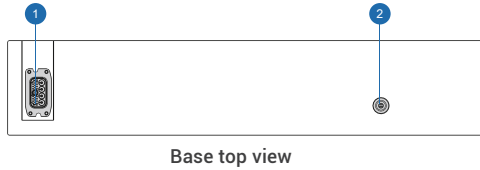

- ① Connection Port for Battery
- ② Position Detector (male)

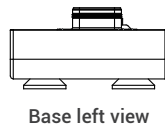
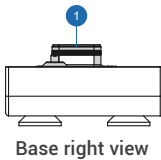

- ① Connection Port for Battery

The base module of residential energy storage system is used to support the whole system, its main functions include:

**Structural support:** for battery module support.

**Electrical circuit closure:** there are connectors on the base to connect with the battery module to achieve high voltage circuit and heating circuit closure.

## 3.6 LED Lights Display Description

### 3.6.1 Battery System LED Display Description



Table1 LED display description



















State	Description	RUN 	ALARM 	FAULT 	Battery SOC indicator 	Discription
Battery system power-up	Normal	on	off	off	Based on real SOC power indication	Standby mode
	Warning	on	Blinking1 <sup>[1]</sup>	off		Equipment is operational but requires maintenance
	Fault	off	off	Blinking2 <sup>[1]</sup>		Device not functioning

Table 2 Battery SOC LED Lights Description

State	Charge mode					Discharge mode					Standstill mode				
	L1	L2	L3	L4	L5	L1	L2	L3	L4	L5	L1	L2	L3	L4	L5
SOC LED lights															
SOC	0~20%	One by one light up	Off	Off	Off	Off	Blinking 2 <sup>[1]</sup>	Off	Off	Off	Off	On	Off	Off	Off
	20%~40%	One by one light up	Off	Off	Off	On	Blinking 2 <sup>[1]</sup>	Off	Off	Off	On	On	Off	Off	Off
	40%~60%	One by one light up	Off	Off	Off	On	On	Blinking 2 <sup>[1]</sup>	Off	Off	On	On	On	Off	Off
	60%~80%	One by one light up	Off	Off	Off	On	On	On	Blinking 2 <sup>[1]</sup>	Off	On	On	On	On	Off
	80%~100%	One by one light up	Off	Off	Off	On	On	On	On	Blinking 2 <sup>[1]</sup>	On	On	On	On	On

[1] refer to explanation table 3

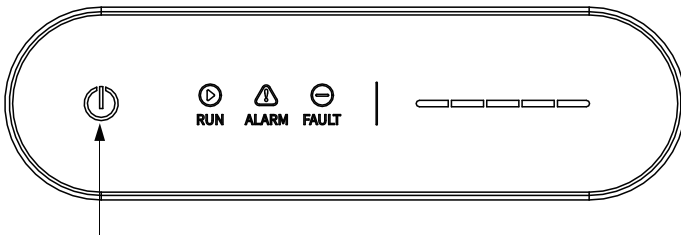

Table 3 Description of LED Blinking

Type	On	Off
Blinking1	0.5s	2s
Blinking2	0.75s	1s
One by one light up	0.5s Forward one frame	

**Notice**

The left status indicator and the right battery capacity indicator are judged independently of each other.



When the battery system is switched on, the power button indicator lights up.  
When the battery system is disconnected, the power button indicator turns off

**Power light State:**

When RESS is turned OFF, the power light status will be "OFF". When RESS is turned ON, the power light status will be "ON". In order to switch "ON" or "OFF" the RESS, we can use the following steps as given below:

**Operation steps:**

- 1, Short press the power button less than 1s, vertical light will flash within 5s;
- 2, Then long press the power button for 5s to 15s, the vertical light will be on for few seconds and turn off and then the power light will turn "ON".

To make sure the steps are correct, power light should be "ON" and vertical light should be "OFF".

If in step2, long press is not within the range of 5s to 15s, the vertical light will flash and power light will remain "OFF";



**Notice**

If no effective press again within 5s (While the Vertical light is flashing, and power light is off,), it will be back to the initial state (vertical light will turn "OFF", and power light is "OFF").

If press effectively again (long press 5s to 15s) , the power light will turn "ON" and vertical light will turn "OFF".

### 3.6.2 Inverter LED Indications



Name of LED	State of LED	Description
SOL	ON	PV is active
	BLINKING	PV is standby
	OFF	PV loss
BAT	ON	Battery is active
	BLINKING	Battery is standby
	OFF	Battery loss
GRID	ON	Grid is active
	BLINKING	Grid is standby
	OFF	Grid loss
EPS	ON	EPS is active
	BLINKING	EPS is overload
	OFF	EPS loss
ERR	ON	Fault state
	BLINKING	Warning
	OFF	No fault

## 4. Installation

---



### Notice

Indicates actions that may cause material damage.

---

### 4.1 Check for Physical Damage

Make sure the inverter is intact during transportation. If there is any visible damage, such as cracks, please contact your supplier immediately.

### 4.2 Equipment Installation

#### Installation Precaution

Smart Lifestyle Australia series is designed for outdoor installation (IP65). Make sure the installation site meets the following conditions:

- Not in direct sunlight.
- Not in areas where highly flammable materials are stored.
- Not in potential explosive areas.
- Not in the cool air directly.
- Not near the television antenna or antenna cable.
- Not higher than altitude of about 2000m above sea level.
- Not in environment of precipitation or humidity (>95%).
- Under good ventilation condition.
- The ambient temperature in the range of -20°C to +55°C.
- The slope of the wall should be within  $\pm 5^\circ$ .
- The wall hanging the inverter should meet conditions below
- The surface should be strong and flat.
  1. Solid brick/concrete, or strength equivalent mounting surface;
  2. Inverter must be supported or strengthened if the wall's strength isn't enough (Such as wooden wall, the wall covered by thick layer of decoration)

Please **AVOID** direct sunlight, rain exposure, snow laying up during installation and operation.

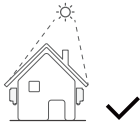

No direct sunlight



No rain exposure



No snow accumulation

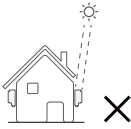

Direct sunlight



Rain exposure



Snow accumulation

### 4.2.1 Requirements

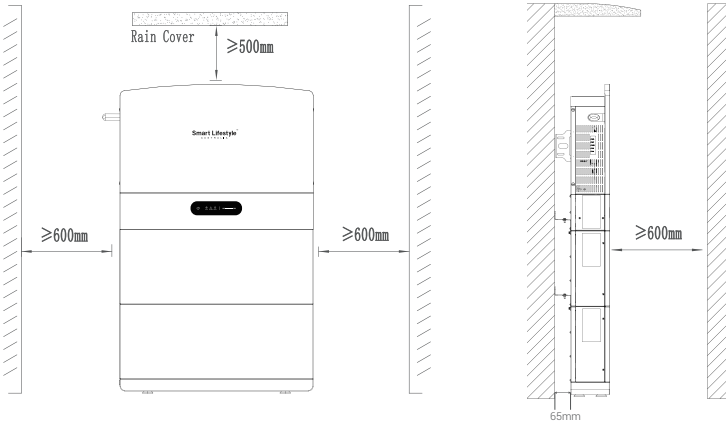

Position	Min size
Left	600mm
Right	600mm
Top	500mm
Front	600mm
Back	65mm

### Mounting Steps

Note: The inverter mount can be stacked on its battery.





## 4.2.2 Required for Installation

Installation tools: crimping pliers for binding post and RJ45, screwdriver, manual wrench etc.

### Installation tools

 Impact Drill ( $\Phi$ 10mm drill)	 Torque Socket Wrench	 Marker Pen	 Vacuum Cleaner
 Torque Wrench	 Torque Screwdriver	 Steel Tape	 Level Ruler
 Electric Batch (with M6 socket)	 Multimeter	 Rubber Mallet	 Wire Stripper
 Wire Cutting Pliers	 Crimping Pliers (for PV terminals)	 Art Knife	 RJ45 Crimping Pliers
 Crimping Pliers (for AC terminals)	 Cable Ties	 Hot Air Gun	 Heat Shrink Tube
 Anti-dirt Blanket	 PV Plug Unlocking Tool		

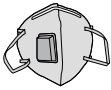
### Personal Protective Equipment

 Safety Gloves	 Safety Goggles	 Dust Mask	 Safety Shoes
--	---	--	---

### 4.3 Installation Process

#### 4.3.1 Battery Pack Installation

The battery pack height must comply with local regulations. If the positioning plate conflicts with the regulations, the regulations must be met first.

**Step 1:** Determine the position of the base: mainly determine the distance from the wall;  
The distance from the wall is 65mm, and keep horizontal;

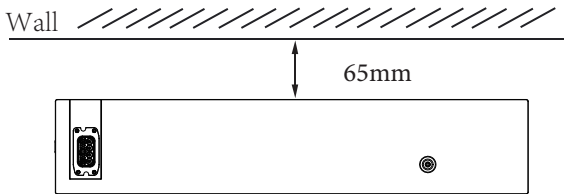

**Step 2:** Use 4 units of M5\*14mm screws to secure the battery bracket on the battery modules and secure the battery; bracket and mounting bracket with 4 units of the same. Both sides need to be installed.

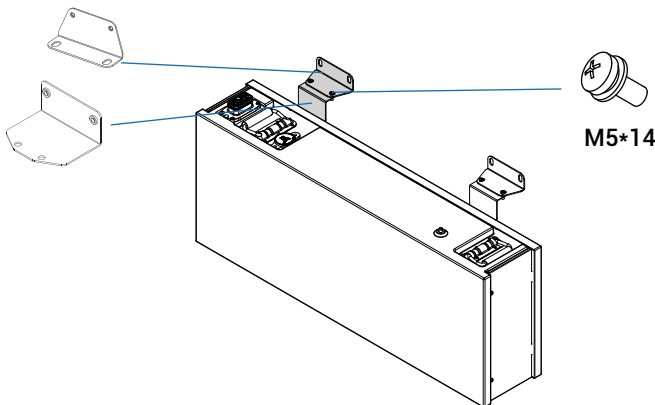

**Step 3:** Use phillips four head screws and four M5x14 unit to install the battery pack, and wall battery mounts. As shown in the following figure.

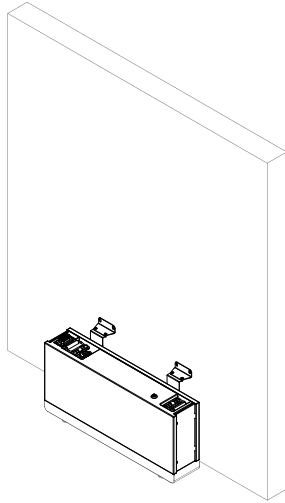

**Step 4:** Use a marker to draw dots at the red intersection in the following image. After drawing the dots, remove the wall battery pendant and use a drill bit to drill holes.

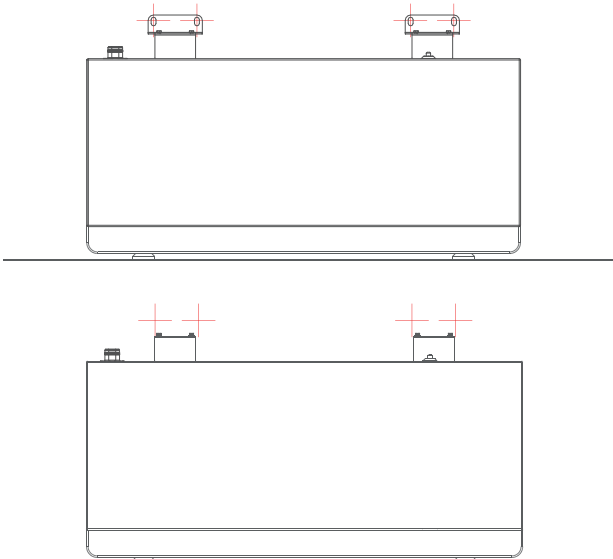

**Step 5:** Install expansion bolts in the drilled holes. Use the expansion bolt with its own M8 nut to fix the wall battery pendant with the expansion bolt. Afterwards, use phillips head screws head screws with M5x14 to fix the wall battery mount and pack mount.

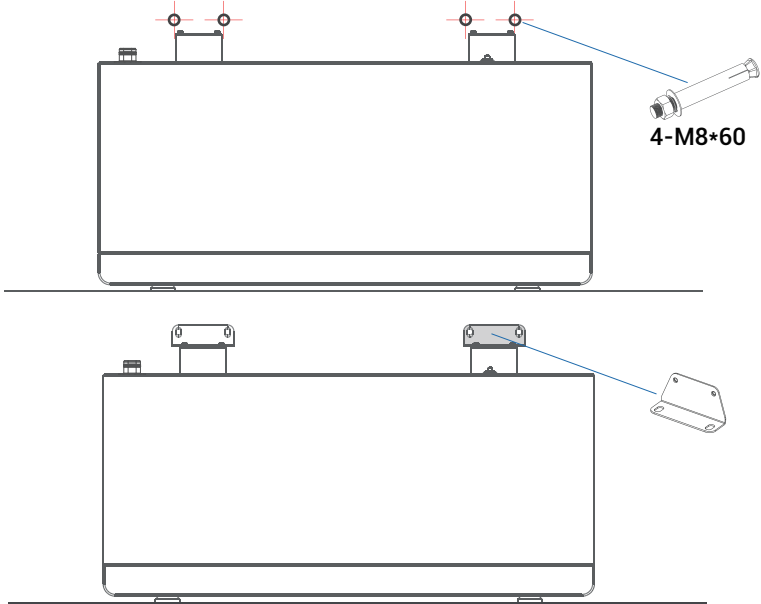

**Step 6:** Repeat steps 2 to 5 to install the other battery modules required. Please align the lower battery with the front of the upper battery during installation.

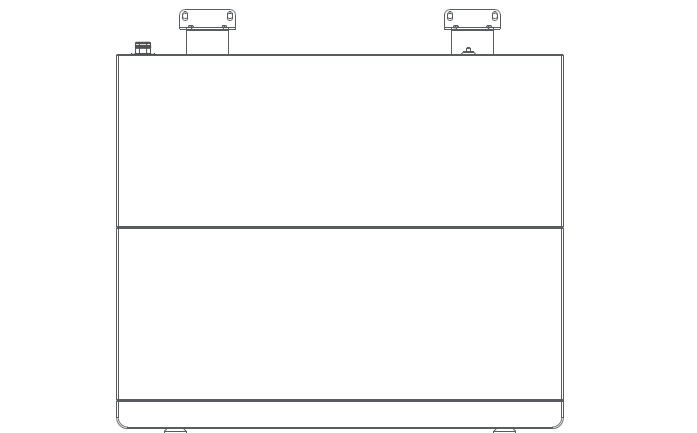



**Step 7:** After installing the battery module, place the BMS control box on top of the battery box. Please align the BMS control box with the front of the lower battery during installation.

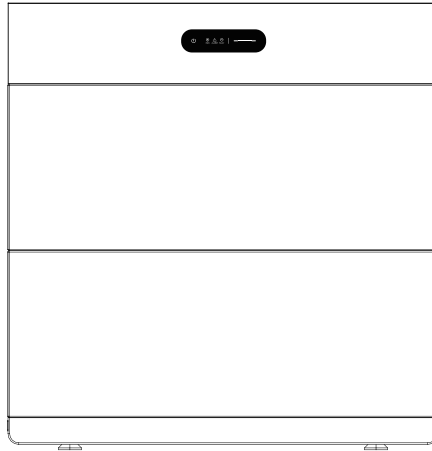

#### 4.3.2 Inverter Installation

**Step 1:** Open the inverter cover on both sides and place the inverter vertically on the BMS control box. It will build the connection between the inverter and battery PACK via "BMS control box and inverter connection cable".

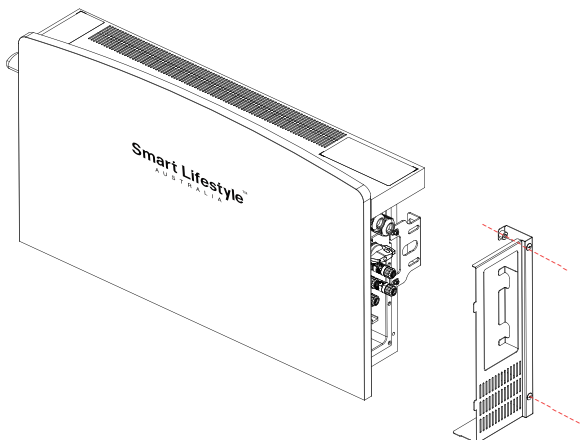

**Step 2:** Place the inverter on the BMS main box, fix the inverter on the mounting bracket, adjust the whole system, and ensure that the battery and inverter are firmly hung on the panel and bracket.

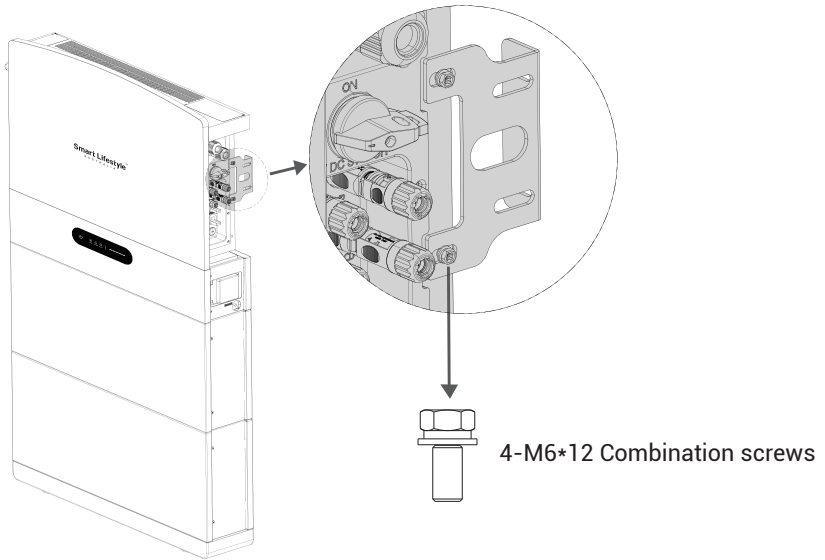

## 5 Electrical Connection

### 5.1 Battery System Cable Connection

The SLA ESS system (without inverter) is cableless installation design which includes pre-installed internal connections. The modular stack installation directly plug-in and completes the series connection between battery modules. The connection between The SLA-BHP system (from BMS main box) and the inverter requires a cable connection using PCS-BAT connector which includes power connection, communication and grounding. There is self-locking rotary spring fastener integrated in the PCS-BAT cable. When the connector is inserted into the socket, the rotary spring fastener is automatically in place and locked to keep permanent connection. Also, there's a separate grounding connection between BMS main box and inverter.

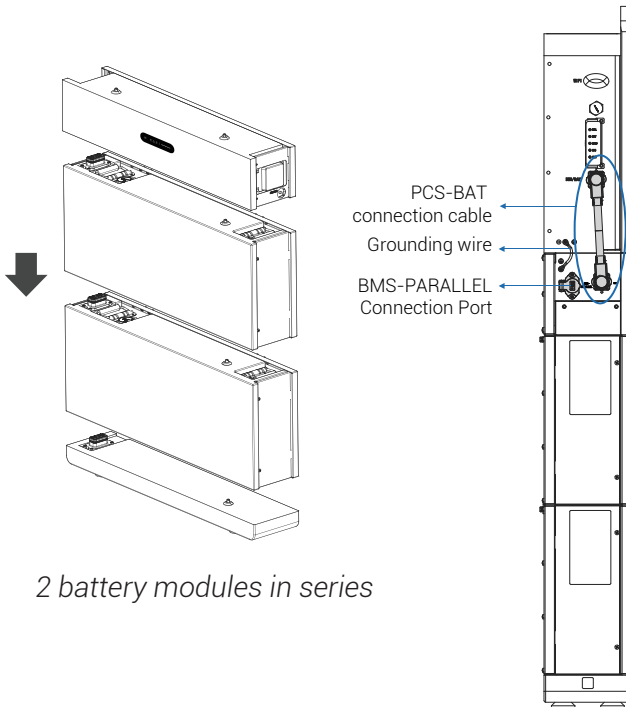

## 5.2 PV Connection



- Before connecting to PV modules, please install a separately DC circuit breaker between inverter and PV modules.
- It is very important for system safety and efficient operation to use appropriate cable for PV module connection. To reduce risk of injury, please use the proper recommended cable size as below.

Wire Size	Cable(mm <sup>2</sup> )
12AWG	4



- To avoid any malfunction, do not connect any PV modules with possible current leakage to the inverter.

- When selecting proper PV modules, please be sure to consider below parameters:

1) Open circuit Voltage (Voc) of PV modules should not exceeds the max. PV port open circuit voltage of inverter.

2) Open circuit Voltage (Voc) of PV modules should be higher than minimum starting PV port voltage of the inverter.

Max. DC Voltage Limitation

Model	SLA-HB-S1-3.8kW1P	SLA-HB-S1-5kW1P	SLA-HB-S1-6kW1P
Max. DC Voltage (V)	600	600	600
MPPT Voltage Range (V)	100-540	100-540	100-540

**Connection Steps:**

**Step 1:** Checking PV module.

- 1.1 Use the digital multimeter to measure the whole installed PV system voltage.
- 1.2 Check the PV+ and PV- from the PV string combiner box correctly.
- 1.3 Please make sure the impedance between the positive pole and negative pole of PV to earth should be open circuit (infinite).

**Step 2:** Separating the DC connector.

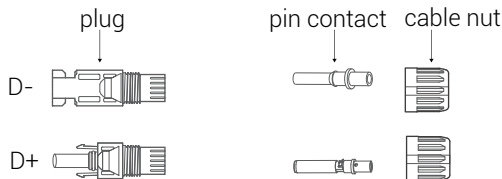

**Step 3:** Wiring

- 3.1 Choose the 4 mm<sup>2</sup> (12 AWG) wire to connect with the cold-pressed terminal.
- 3.2 Remove 10mm of insulation from the end of wire.
- 3.3 Insert the insulation into pin contact and use crimping plier to clamp it.



**Step 4:** Insert pin terminal through the cable nut to assemble into back of the male or female plug. When you feel or hear a “click” sound the pin terminal assembly is seated correctly.

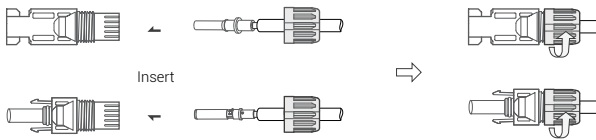

**Step 5:** Plug the PV connector into the corresponding PV terminals on inverter.

### 5.3 Ac Input/Output Connection

Before connecting the grid connection, please install a separate AC circuit breaker between inverter and AC input from the Grid side. This will ensure the inverter can be securely disconnected during maintenance and fully protected from over current of AC input from the Grid side. The recommended current rating of AC circuit breaker is 32A.

**Table: Cable and Circuit breaker recommended**

Model	SLA-HB-S1-3.8kW1P	SLA-HB-S1-5kW1P	SLA-HB-S1-6kW1P
Cable	6mm <sup>2</sup> (9 AWG)	6mm <sup>2</sup> (9 AWG)	6mm <sup>2</sup> (9 AWG)
AC breaker	32A	32A	32A



#### Warning!

There is "L" "N" "PE" Symbols marked inside the connector; the live wire of grid must be connected to "L" terminal; the Neutral wire of grid must be connected to "N" terminal; the Earth of grid must be connected to "PE"

### Tools required for installation.

Installation tools: open-end wrench, wire stripper, 2.0 Allen driver, 6-side Rivet pliers, etc.

#### Installation tools



open-end wrench



wire stripper



2.0 Allen driver



6-side Rivet pliers

**a:** Use professional tools to peel off the cables according to the requirements in the table below.

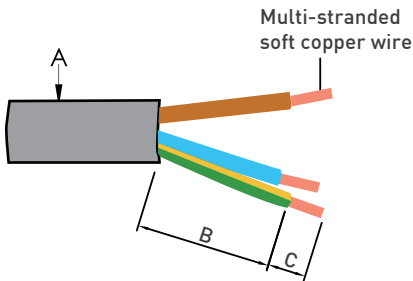

No.	clarification	Size data
A	Outer diameter of wire	∅12mm-∅18mm
B	Bare wire length	31±5mm
C	Wire length	9±0.5mm

**b:** Insert the conductor into the suitable ferrule acc. to DIN 46228-4 and crimp the contact.



6mm<sup>2</sup> non-insulated cord end Terminal Recommended model: EN6012

**c:** Unscrew the swivel nut from the threaded sleeve and thread the swivel nut and threaded sleeve over the AC cable.

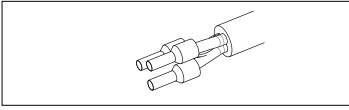

Crimp the terminals with crimping pliers

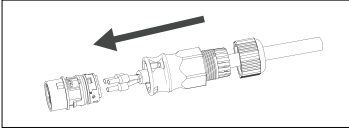

Set the parts on the cable, Insert the terminal holes in sequence

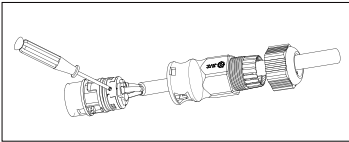

Crimp the wire with a hexagonal screwdriver and turn the screw. torque  $1.2 \pm 0.1 \text{ N}\cdot\text{m}$  ( $2.5 \sim 6 \text{ mm}^2$ )  $1.0 \pm 0.1 \text{ N}\cdot\text{m}$  ( $\leq 2.0 \text{ mm}^2$ )

**Note:** It is necessary to wire according to the L, N, and PE labeling instructions of the plug-in.

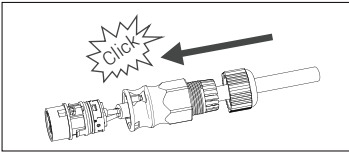

Insert the main body into the rubber core and hear the "click" sound

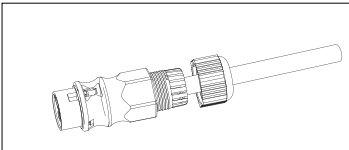

Tighten the nut with an open-ended wrench (torque  $2.5 \pm 0.5 \text{ N}\cdot\text{m}$ )

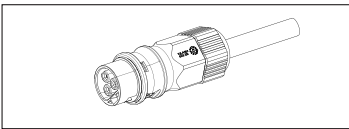

complete the installation

### Male and female terminals

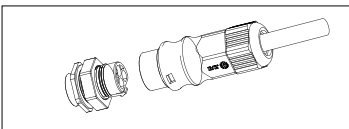

The installation arrow indicates insertion the male connector

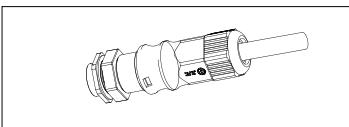

complete the installation

## Unlock instructions

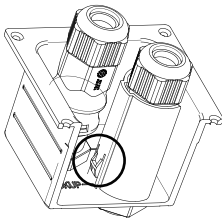
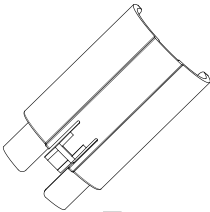
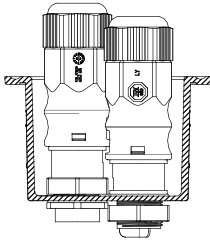

Place the unlocking tool onto the corresponding product.

Press the button on the unlocking tool with your finger or a flathead screwdriver

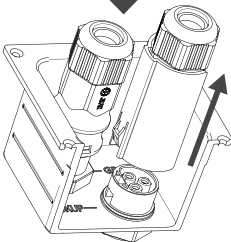

Pull the product outwards to complete the split

**Note:** The disassembling and assembling methods and procedure operation for the male plug-in is the same as that for the female plug-in.



## 5.4 Communication Interface Connection

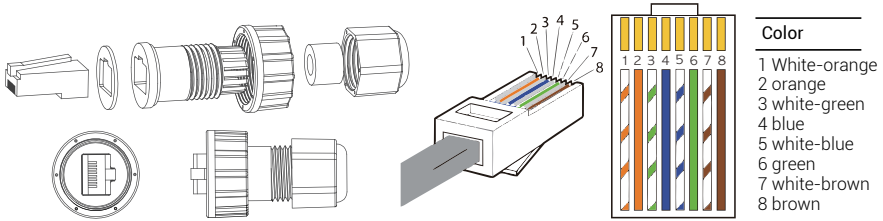

### 5.4.1 PM(METER/CT) Interfaces

This interface is connected with Smart meter or CT clamp. The smart meter/CT clamp should be mounted and connected at the grid transition point (feed-in point) so that it can measure the grid reference and feed-in power. The communication method between PM interface and smart meter/CT clamp is RS485. This port can support up to two external CT and one smart meter. Currently CT1 pins are enabled and CT2 pins are disabled for single phase PCS. The PM(METER/CT) Interface uses 485 communication method to read the voltage, current, active power, reactive power, apparent power and other information collected by the smart meter/CT clamp. Before communicating with the smart meter, the baud rate (96kbps) and address information of the smart meter need to be set through the "Solarman Business" APP.

Pin	Description	Pin	Description
1	485A	5	GND
2	485B	6	CT2B
3	CT2A	7	CT1A
4	VCC	8	CT1B

\*Refer to 5.4 for wiring sequence

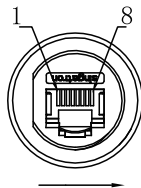

Interface Description

1. The installer will prepare the network cable and the length of the cable will be determined according to the site environment.

- Remove the cable insulation and make the RJ45 connector according to the cable line order
- Open the CT cap, place it on the grid main line "L" cable so that the arrow of the CT points towards the direction of the power grid, and then close the cap.

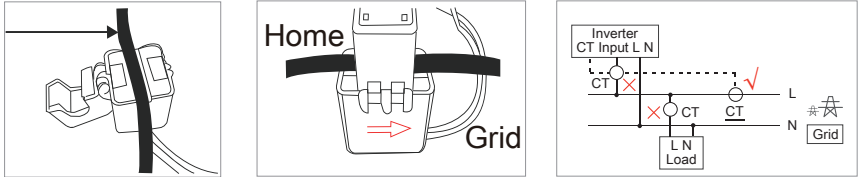

- Connect the S1 and S2 cables (Ports) of the CT to the number 7 and 8 port of the RJ45 adapter respectively, and connect the wires as shown below in the diagram.

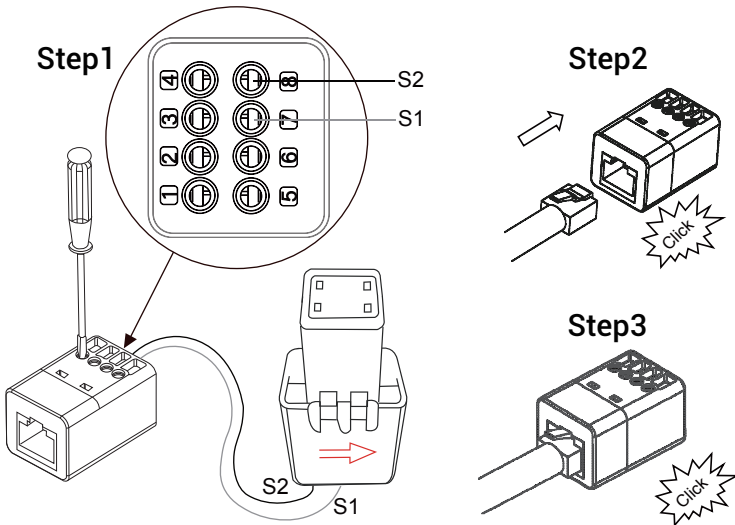

- Plug both ends of the RJ45 cable into the RJ45 adapters and the PM(METER/CT) Interface on Inverter as shown above.



**Notice**

**Note:**

Make sure the grid main power breaker and PV DC switch are turned OFF during the installation.



### Notice

CT should be placed near the power grid.

If CT clamp test pass but inverter still can't achieve export power (power is not controllable or always 0 power output). Please check installation location of the CT.

## 5.4.2 DRM Port Connections (Optional)

This interface is a dry contact (only for Australia). DRED means demand response enable device. The AS/NZS 4777.2:2020 required inverter needs to support demand response mode (DRM). This function is for inverter that comply with AS/NZS 4777.2:2020 standard. Inverter is fully complied with all DRM. The corresponding functions are enabled by DRED equipment and host computer. For details, refer to AS4777. A RJ45 terminal is used for DRM connection

Pin	Description	Pin	Description
1	DRM1/5	5	REF
2	DRM2/6	6	COM
3	DRM3/7	7	VCC
4	DRM4/8	8	GND

\*Refer to 5.4 for wiring sequence.

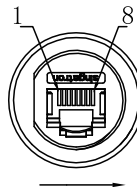

Interface Description

## DEMAND RESPONSE MODES (DRMs)

Mode	Pin	Description
DRM 0		Operate the disconnection device
DRM 1		Do not consume power
DRM 2		Do not consume at more than 50% of rated power
DRM 3		Do not consume at more than 75% of rated power AND Source reactive power if capable
DRM 4		Increase power consumption (subject to constraints from other active DRMs)
DRM 5		Do not generate power
DRM 6		Do not generate at more than 50% of rated power
DRM 7		Do not generate at more than 75% of rated power AND sink reactive power if capable
DRM 8		Increase power generation (subject to constraints from other active DRMs)

### 5.4.3 COM/LCD Interface

This interface is a dry contact. COM port uses RS485 communication, the communication protocol is the same as WIFI port 485 protocol, used for client power grid scheduling monitoring.

Pin	Description	Pin	Description
1	D02A	5	GND
2	D02B	6	485B
3	485A	7	D01A
4	VCC	8	D01B

*\*Refer to 5.4 for wiring sequence.*

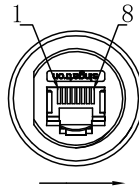

Interface Description

### 5.4.4 PARALLEL(INV) Interface

The function of PARALLEL(INV) interface is to connect two inverters via parallel connection mode. The communication happens via CAN BUS protocol.

Pin	Description	Pin	Description
1	CANH	5	MCANL
2	NC	6	CANL
3	NC	7	NC
4	MCANH	8	NC

*\*Refer to 5.4 for wiring sequence.*

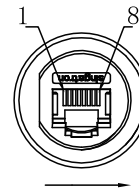

Interface Description

### 5.5 External Smart Meter(optional) Connection

You must connect external CTs or a smart meter between the inverter and the power grid. If you want to connect a smart meter. Please note that only one meter is necessary for each inverter. The meter must be mounted and connected at the grid transition point (feed-in point) so that it can measure the grid data and feed-in power.

## PROCEDURE

**STEP1:** Prepare the communication wires, power cable, and tools for the meter connection .

**STEP2:** Selection of a suitable location for fixing the DIN track, Mount the Meter on the DIN track.

**STEP3:** Installation of CT. Refer to the introduction of CT installation for specific steps.

**STEP4:** Install the cables correctly as shown.

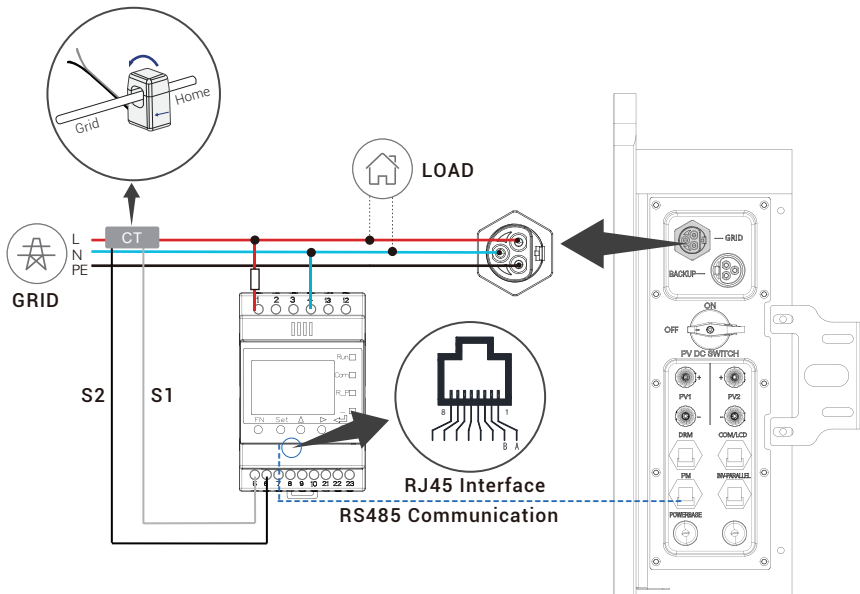

Wiring of Smart Meter Connection (Example, ACRIORH-D10TE)

## 5.6 Earth Fault Alarm Connection

The inverter complies with IEC 62109-2 13.9. The fault indicator LED on the inverter will light up and the app will give a message of an error code of F40 indicating the earth fault.

The inverter should be installed at height range for convenient maintenance (Adjust the height by placing the foundation)

## 5.7 Wiring Diagram

SLA Hybrid Series is designed with two EPS versions for customer to choose based on the local rules.

E Version applies to the wiring rules that requires the Live line and N (Neutral) line of EPS must be disconnected with the Live line and N (Neutral) line of grid (applies to most of the countries).

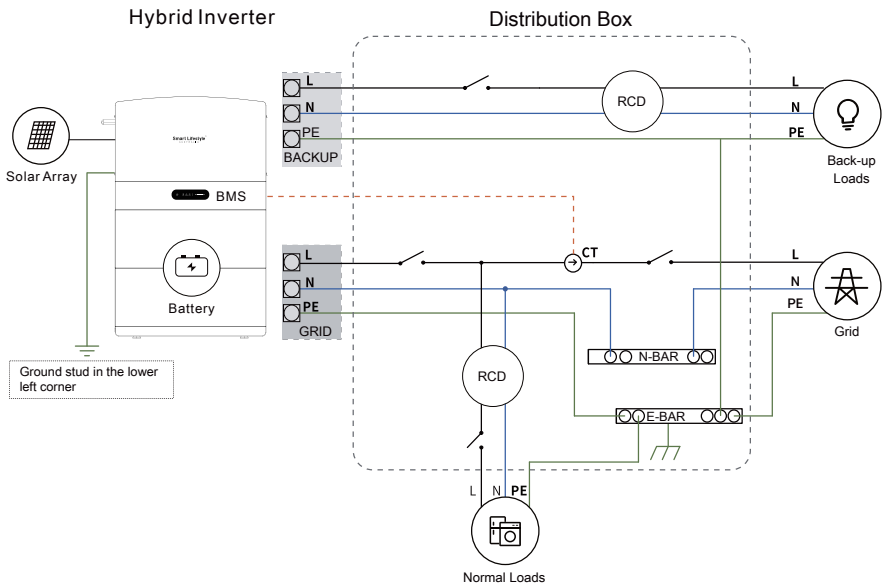

### E Version

For Australia, New Zealand. The neutral points on the GRID side and the LOAD side must be connected together, otherwise the LOAD function does not work. PE grounding: 1. The PE terminal of LOAD is vacant and cannot be connected to the grid system of Australia, New Zealand and South Africa. 2. There are two PE earthing posts on the PCS shell, one is connected to the shell earthing post of the BMS control box to maintain earthing continuity between different structural parts, and the other PE earthing post needs to be reliably connected to the building earthing nearby.

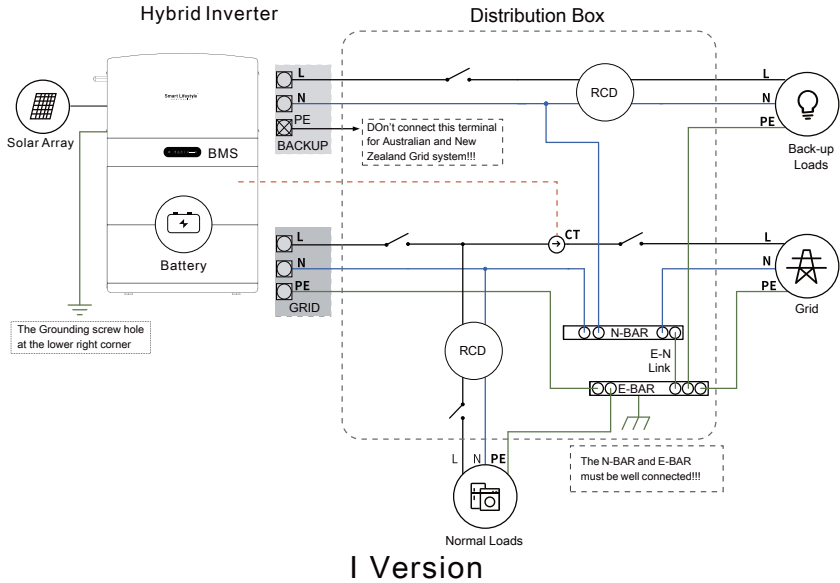

### 5.8 Battery Pack Capacity Expansion

- Capacity 10.2 kWh: 2× battery module+1× BMS control box+ 1× base
- Capacity 15.3 kWh: 3× battery module+1× BMS control box+1×base
- Capacity 20.4 kWh: 4× battery module+2× BMS control box+2×base
- Capacity 30.6 kWh: 6× battery module+2× BMS control box+2×base

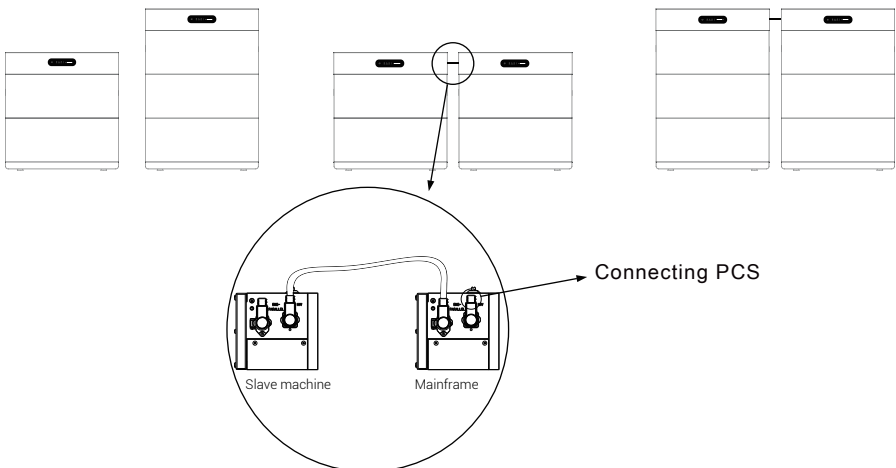

Parallel cable for BMS control box (2×BMS control box need)



**Notice**

After completing the product installation, end users are not supported to expand the battery capacity by themselves, the battery pack capacity must be determined before installation.

## 6 System Operation

### 6.1 Power on the System

When turning on the system, it is compulsory to follow the steps below to prevent the damage to the system.

**WARNING:** Please check the installation again before turning on the system.

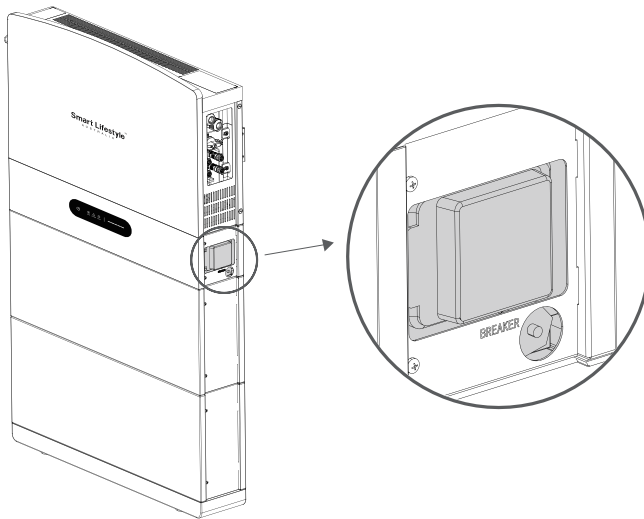

**SLA RESS Power-on steps:**

**Step 1.** Turn the grid-side circuit breaker "ON"

**Step 2.** Turn the photovoltaic isolation switch "ON"

**Step 3.** Open the protective cover and turn the BMS control box circuit breaker "ON"

**Step 4.** Press the power button on BMS control box and check the status of the LED lights.



## 6.2 Switch Off

**Step 1:** Press the power button on BMS control box and check the status of the LED lights

**Step 2:** Open the protective cover and turn the BMS control box circuit breaker "OFF"

**Step 3:** Turn the grid-side circuit breaker "OFF".

## 7 Plant Monitoring

### 7.1 Create a Plant

Owners can create your own plant at SOLARMAN Platform to run a real-time monitoring. System will collect the data from associated devices, which enables a full understanding of PV plant running status.

#### Step 1: "Add Now"

Click "Add Now" to create your plant at SOLARMAN Platform.

Notice: If you have already created a plant, you will not see this page. And if you wish to create another plant, please click "+" in the upper-right corner and select "Create a Plant".

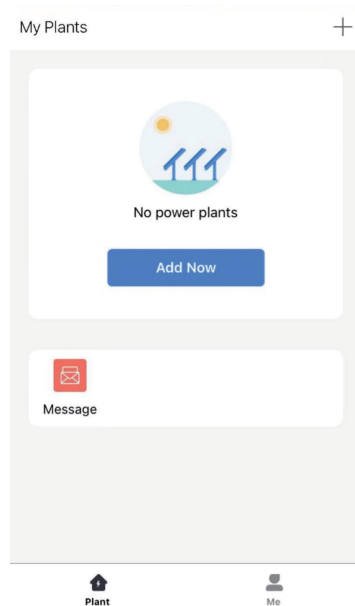

When you enter the following page, please select according to your own situation. If your plant has an installer to do O&M in the later stage, it is recommended that do Not create plant by yourself.

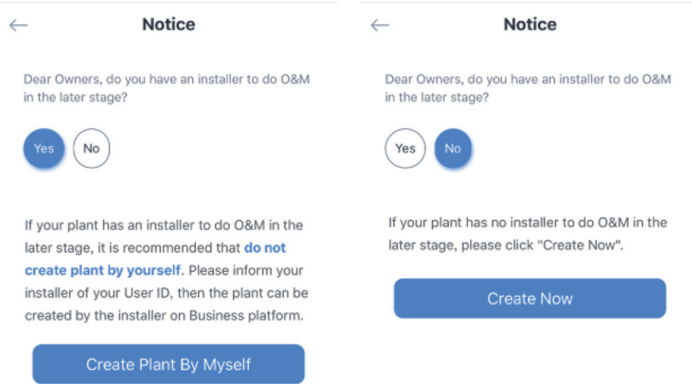

### Step 2: Enter Plant Details

Please enter detailed plant information according to your actual situation. System will create a unique plant for you. In order to calculate plant data precisely, please enter:

- (1) Plant Name,
- (2) Plant Type: Residential Rooftop
- (3) System Type: Storage System

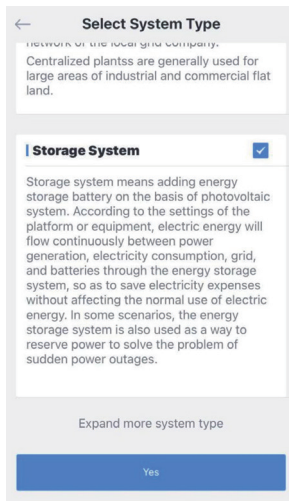

- (4) Plant Location,
- (5) Installed Capacity,
- (6) Time Zone,
- (7) Other information.

### Please notice:

(1) Click  to switch between Google Maps and Amap. Amap will enhance searching & locating ability in China. Google Maps will enhance searching & locating ability globally. Please select accordingly.

(2) Click  to switch between 2D Plane Map and Satellite Map.

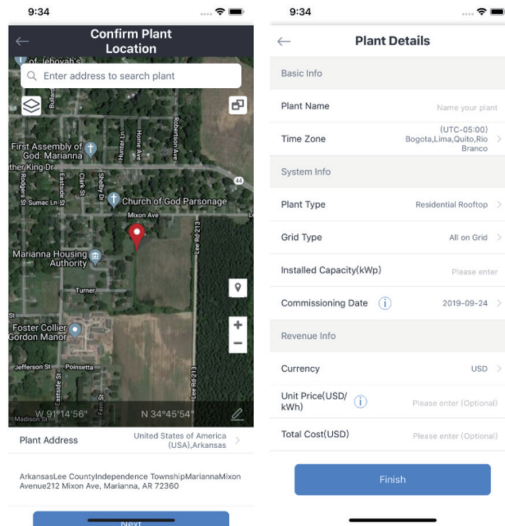

**Notice:** If your plant has no data after you click "Finish", which means there is no device in your plant.

## 7.2 Add a Logger

After the plant is created, you can add a logger. Logger can collect running data from PV devices and upload to cloud server, which enables a full understanding of PV plant running status and revenue information. Furthermore, online platform will determine whether the plant is running normally, which avoid property loss caused by device failure and other reasons.

**Step 1:** go to add logger

Once the plant is created, you can see the page as below, please click the “Go to Add”

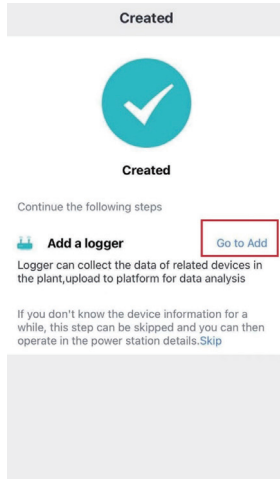

**Step 2:** Enter Logger SN

You can enter logger SN manually or click icon in the right to scan SN.

The SN number and the QR code are on the cover of the data dongle, you can find it there.

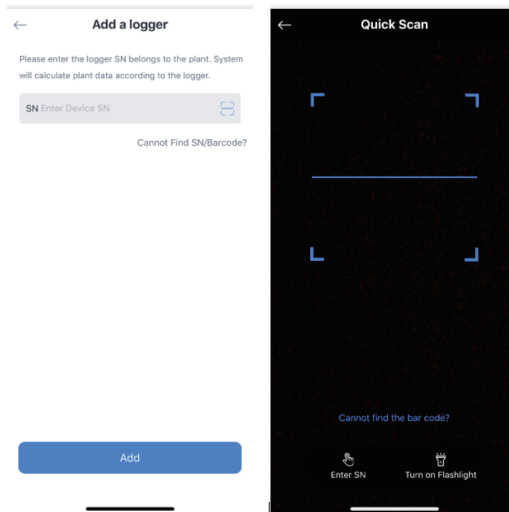

**Notice:** If failed to scan the QR code or the scan result data is different with the SN number in the label, please input SN code manually.

## 7.3 Networking Configuration

Once finished add the logger SN, then begin to network configuration.

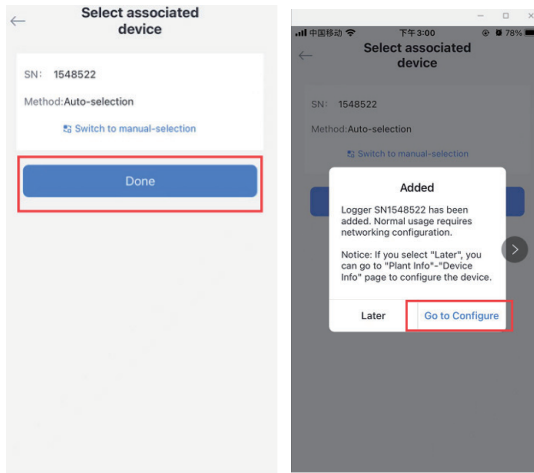

### Step 1: Confirm WIFI Info

Please make sure your phone has connected to the right WIFI network and click "Start"

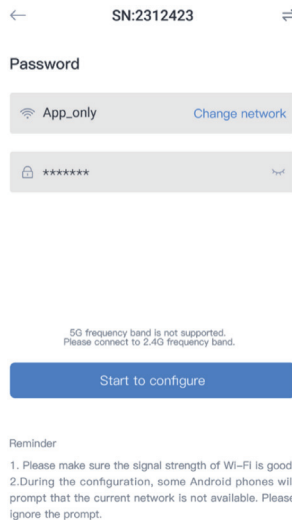

## Step 2: Auto Configuration

Please wait for a while to complete the configuration. System will switch to the Configured Page automatically. When you go back to "Device List", the logger will still at Offline status. Usually, the data will be updated in 10 mins. Please wait patiently.

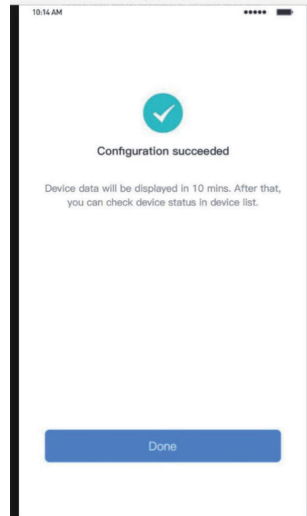

Please keep Bluetooth ON during the configuration.

If configuration failure occurs, please check the following reasons and try it again.

1. Make sure the WLAN is on;
2. Make sure WIFI is normal;
3. Make sure wireless router does not implement the white-black list;
4. Shorten the distance between the phone and device;
5. Try to connect to other WIFI;
6. Remove the special characters in WIFI network.

## 8 APP Data View

After the plant and device setup is done, you can check plant data remotely.

**Notice:** Please check plant data 10 minutes later after network configuration.

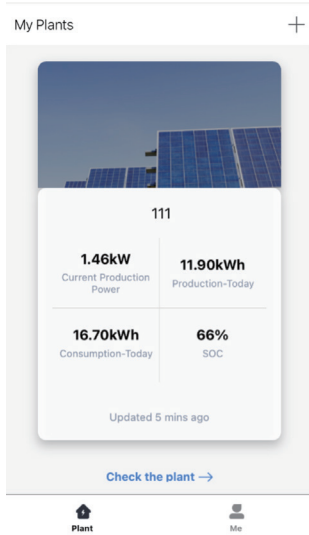

### 8.1 Real Time Data

Click the plant as shown above, you can check various data on this page. E.g., Flow Chart, 24H Curve, Production, Consumption, anticipated yield, etc.

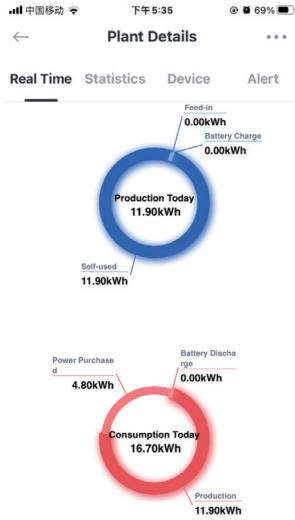
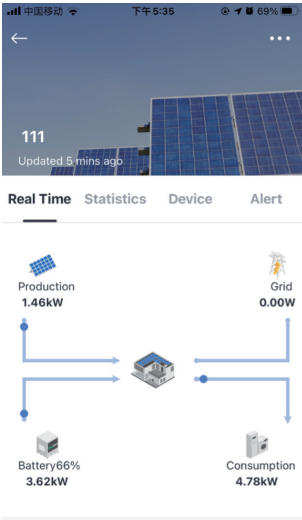



## 8.2 Statistics Data

You can check plant statistics and historical data on this page. You can filter specific date and conditions to query.

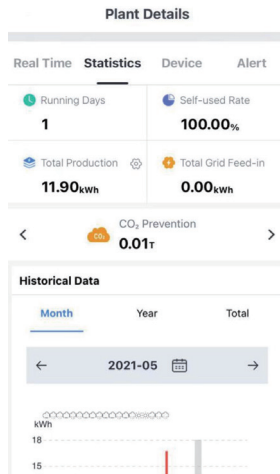

## 8.3 Device Info

- 1) Follow the guidelines in section 8.1 to enter the power station details, switch to the device page and click on the inverter to enter.
- 2) Slide the page to find the information of the settings and firmware version.

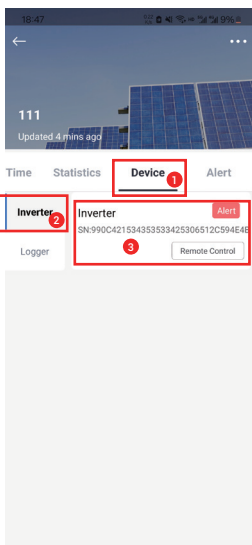

## 8.4 Alert Data

You can check plant alert on this page. Alert will be distinguished from alert importance and alert content, which enables you to understand the importance of alerts. Through these alert messages, you can learn the fault status of your plant, which avoids property loss.

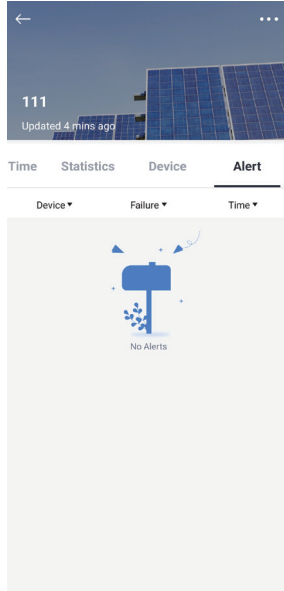

## 9 Remote Setup for Installers

Permission to operate commands and firmware is only granted by the authorized account. Installers get the authorized accounts from distributor that has super admin account. The super admin was authorized by Smart Lifestyle Australia. Unauthorized accounts do not have access to commands or firmware.

Once settings are selected at commissioning they are locked to view only.

### 9.1 Grid Regional Standard

Click "Remote control" to move corresponding options.

"Read" is for downloading the data of current device,

"Setup" is for uploading the set-up value.

Under "Grid Code", choose between Australia A Australia B Australia C according to the actual grid standard to which the device is connected.

Notice: The grid-connected relay will not engage until Australia Region A,B,C is selected according to the section 4.1 of AS4777.2 2020.

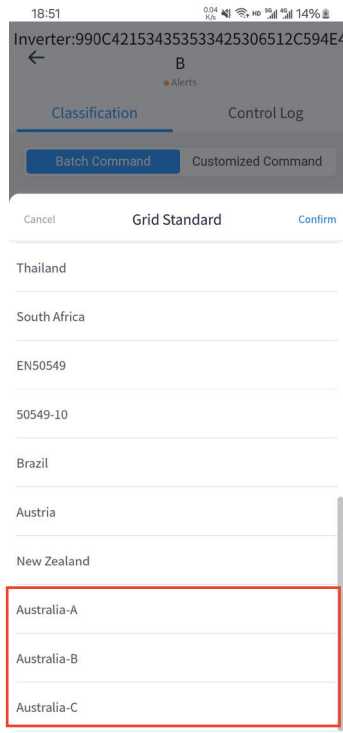
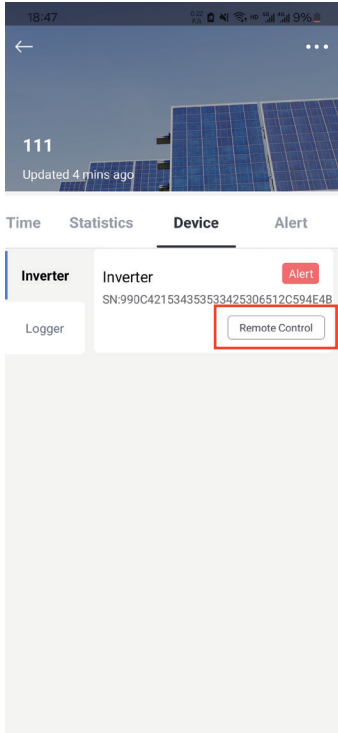

## 9.2 Grid Protection Value and Power Quality Response

When you completed the selection of grid standard, the grid setting will be automatically adjusted to the values what corresponding grid standard requires.

After selecting the regional standard, you can also set the protection values (if required) like grid over-frequency, under-frequency, over-voltage and under-voltage protection points etc.

In the command, you can set the "over frequency derating enable" to enable, write the "over frequency derating frequency" value and the "power retardation" value, so that when the grid frequency exceeds the over frequency derating frequency, the device will derate the active power in accordance with a certain gradient.

The Volt-Watt model and Volt-Var model also can be set in power quality setting

Notice: Once the power quality and grid settings have been selected at commissioning these settings will be locked automatically locked. from editing (unless using super admin account)

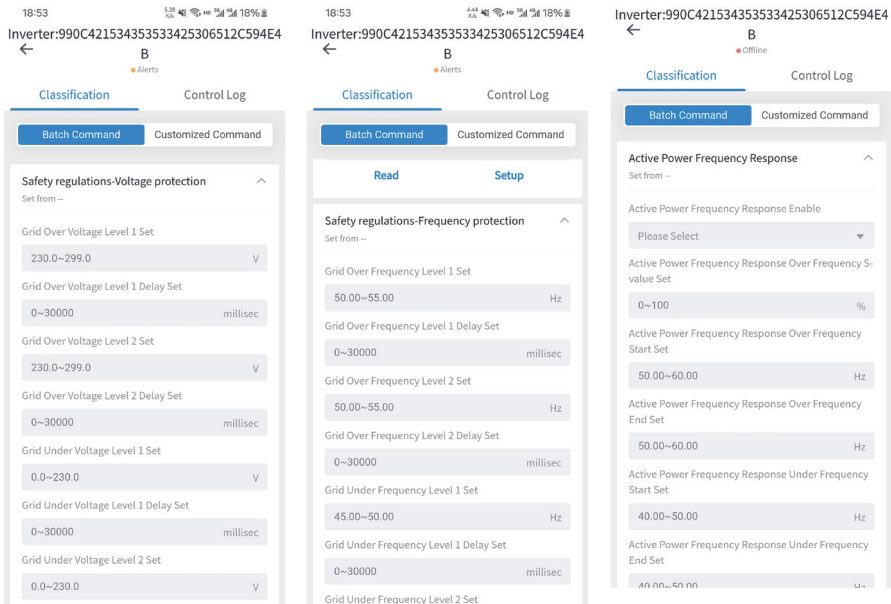

## 9.3 Advanced Function

### -Export output limit

Limiting inverter power to be injected into the grid, disable by default.

When export limit is required by local grid standards and requirements, click "Export output Limit Enable" and enable this function and then enter detailed value of export output limiting. This function is controlled completely by soft limit.

**Soft limit:** Reducing power output by software when the feed-grid current is higher than the limit value.

**Hard limit:** After enabling this function, the inverter and the utility grid will automatically disconnect when the power feeds into the grid exceeds the required limit.(hard export limit control is not currently available and will be enabled in the future).

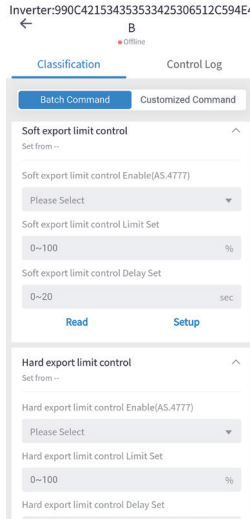

### -Grid power limit

Just set percent value depends on nominal AC power to limit generation power.

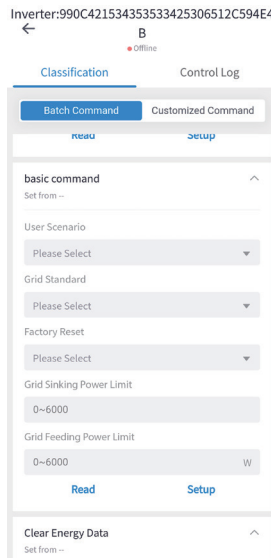

## -DRM (Demand Response Mode)

Only applicable in Australia and New Zealand. Default option is disabling.



### Notice

#### Note:

If you need help during installation and use you can contact us through the after-sales channel.

---

## 10 Maintenance

### 10.1 Maintenance Before Operation

1. Before the inverter is put into operation, read the instruction manual carefully, and strictly execute the connection and installation of the equipment according to the instructions on the manual.
2. Carefully check whether the various parts of the inverter as well as the terminals are loose and fall off in the process of transporting.
3. Carefully check whether the diameter of each wire of the inverter is in accordance with the requirements; whether the insulating property is good or not; and whether the grounding of the system is in accordance with insulation regulations or not. Note: When using the inverter, it should be operated in strict accordance with the instructions for using and maintaining the inverter, and the warning signs on the inverter should be intact.

## 10.2 Maintenance During Operation

1. In the process of inverter commissioning, regularly check whether the inverter wirings are firm, and check whether the dust net, fan, power module, terminals and other parts are working normally.
2. The inverter cabinet has high pressure, usually should pay attention to check whether the cabinet door is locked or not.
3. When the room temperature exceeds 30 °C, effective cooling measures should be taken to prevent the inverter from overheating and burning.
4. The structure and electrical connection of the inverter should be kept intact, and there should be no corrosion, accumulation of dust, etc. The inverter should not have large vibration and abnormal noise during operation.
5. Regularly disconnect the circuit breaker of AC output side of the inverter once.
6. When the DC bus capacitor temperature in the inverter is too high or exceeds the service life, it should be found and replaced in time.
7. The inverter belongs to high reliable operation equipment, can achieve long-term trouble-free operation, weekdays should carry out inspections, listen to the inverter sound is normal, the external debris, whether the vent is dusty, the panel display is normal, found that the problem is dealt with in a timely manner.

**Note:** Non-professionals should not disassemble and overhaul the inverter without permission. Inverter generally have short circuit, over current, over voltage, overheating and other items of automatic protection, when the problem occurs, do not need to manually shut down.



# 11 Troubleshooting

## 11.1 System Fault Information table

NO.	Fault name	Solution
1	NVM checksum failure	Switch off the grid side AC circuit breaker, PV DC switch and battery circuit breaker, then switch them on 5 minutes later. Contact SLA service if the problem persists.
2	DSP communication failure	Switch off the grid side AC circuit breaker, PV DC switch and battery circuit breaker, then switch them on 5 minutes later. Contact SLA service if the problem persists.
3	BMS communication failure	Switch off the grid side AC circuit breaker, PV DC switch and battery circuit breaker, then switch them on 5 minutes later. Contact SLA service if the problem persists.
4	Battery overvoltage alarm	Switch off the grid side AC circuit breaker, PV DC switch and battery circuit breaker, then switch them on 5 minutes later. Contact SLA service if the problem persists.
5	Battery undervoltage alarm	Switch off the grid side AC circuit breaker, PV DC switch and battery circuit breaker, then switch them on 5 minutes later. Contact SLA service if the problem persists.
6	Battery overtemperature alarm	Switch off the grid side AC circuit breaker, PV DC switch and battery circuit breaker, then switch them on 5 minutes later. Contact SLA service if the problem persists.
7	Battery under temperature alarm	Switch off the grid side AC circuit breaker, PV DC switch and battery circuit breaker, then switch them on 5 minutes later. Contact SLA service if the problem persists.
8	Battery overcurrent alarm	Switch off the grid side AC circuit breaker, PV DC switch and battery circuit breaker, then switch them on 5 minutes later. Contact SLA service if the problem persists.
9	Battery voltage difference too large	Switch off the grid side AC circuit breaker, PV DC switch and battery circuit breaker, then switch them on 5 minutes later. Contact SLA service if the problem persists.
10	Temperature difference too large	Switch off the grid side AC circuit breaker, PV DC switch and battery circuit breaker, then switch them on 5 minutes later. Contact SLA service if the problem persists.
11	Battery SOC too high	Switch off the grid side AC circuit breaker, PV DC switch and battery circuit breaker, then switch them on 5 minutes later. Contact SLA service if the problem persists.
12	Battery SOC too low	Switch off the grid side AC circuit breaker, PV DC switch and battery circuit breaker, then switch them on 5 minutes later. Contact SLA service if the problem persists.

13

Other battery alarms

Switch off the grid side AC circuit breaker, PV DC switch and battery circuit breaker, then switch them on 5 minutes later. Contact SLA service if the problem persists.

## 11.2 Inverter Fault Information

NO.	Fault name	Solution
1	Grid over voltage	<ol style="list-style-type: none"> <li>1. If the problem occurs occasionally, the distribution grid may be abnormal temporarily. The inverter will recover automatically after detecting that the distribution grid is normal.</li> <li>2. If the problem occurs frequently, check whether the grid voltage is within the permissible range.</li> <li>3. Contact the local distribution company if the grid voltage exceeds the permissible range.</li> <li>4. Modify the overvoltage protection threshold, HVRT or disable the overvoltage protection function after obtaining the consent of the local distribution company if the grid frequency is within the permissible range.</li> <li>5. Check whether the AC circuit breaker and the output cables are connected securely and correctly if the problem persists.</li> </ol>
2	Grid under voltage	<ol style="list-style-type: none"> <li>1. If the problem occurs occasionally, the distribution grid may be abnormal temporarily. The inverter will recover automatically after detecting that the distribution grid is normal.</li> <li>2. If the problem occurs frequently, check whether the grid voltage is within the permissible range.</li> <li>3. Contact the local distribution company if the grid voltage exceeds the permissible range.</li> <li>4. Modify the overvoltage protection threshold, HVRT or disable the overvoltage protection function after obtaining the consent of the local distribution company if the grid frequency is within the permissible range.</li> <li>5. Check whether the AC circuit breaker and the output cables are connected securely and correctly if the problem persists then contact SLA service.</li> </ol>
3	Grid over current	<ol style="list-style-type: none"> <li>1. If the problem occurs occasionally, the distribution grid may be abnormal temporarily. The inverter will recover automatically after detecting that the distribution grid is normal.</li> <li>2. Contact SLA if the problem occurs frequently.</li> </ol>
4	Grid frequency abnormal	<ol style="list-style-type: none"> <li>1. If the problem occurs occasionally, the distribution grid may be abnormal temporarily. The inverter will recover automatically after detecting that the distribution grid is normal.</li> <li>2. If the problem occurs frequently, check whether the grid frequency is within the permissible range.</li> <li>3. Contact the local distribution company if the grid frequency exceeds the permissible range.</li> <li>4. Modify the frequency protection threshold or disable the over frequency protection function after obtaining the consent of the local distribution company if the grid frequency is within the permissible range.</li> </ol>

5	DC bus over voltage	Switch off the grid side AC circuit breaker, PV DC switch and battery circuit breaker, then switch them on 5 minutes later. Contact SLA service if the problem persists.
6	DC bus under voltage	Switch off the grid side AC circuit breaker, PV DC switch and battery circuit breaker, then switch them on 5 minutes later. Contact SLA service if the problem persists.
7	PCS over temperature	<ol style="list-style-type: none"> <li>1. Check the ventilation and the ambient temperature at the installation location.</li> <li>2. If the ventilation is poor or the ambient temperature is too high, improve the ventilation and heat dissipation.</li> <li>3. Contact SLA service if both the ventilation and the ambient temperature are normal.</li> </ol>
8	PV over temperature	<ol style="list-style-type: none"> <li>1. Check the ventilation and the ambient temperature at the installation location.</li> <li>2. If the ventilation is poor or the ambient temperature is too high, improve the ventilation and heat dissipation.</li> <li>3. Contact SLA service if both the ventilation and the ambient temperature are normal.</li> </ol>
9	PVA over current	Switch off the grid side AC circuit breaker, PV DC switch and battery circuit breaker, then switch them on 5 minutes later. Contact SLA service if the problem persists.
10	PVB over current	Switch off the grid side AC circuit breaker, PV DC switch and battery circuit breaker, then switch them on 5 minutes later. Contact SLA service if the problem persists.
11	BuckBoost A over current	Switch off the grid side AC circuit breaker, PV DC switch and battery circuit breaker, then switch them on 5 minutes later. Contact SLA service if the problem persists.
12	BuckBoost B over current	Switch off the grid side AC circuit breaker, PV DC switch and battery circuit breaker, then switch them on 5 minutes later. Contact SLA service if the problem persists.
13	Battery side DC over voltage	<ol style="list-style-type: none"> <li>1. If the problem occurs occasionally, check battery input voltage, if it 's within normal range, the inverter will recover automatically.</li> <li>2. Contact SLA service if the problem occurs frequently.</li> </ol>
14	Battery side DC under voltage	<ol style="list-style-type: none"> <li>1. If the problem occurs occasionally, check battery input voltage, if it 's within normal range, the inverter will recover automatically.</li> <li>2. Contact SLA service if the problem occurs frequently</li> </ol>

---

15	PVA over voltage	Check the serial connection of the PV array. Make sure that the open circuit voltage of the PV string is not higher than the maximum operating voltage of the inverter.
16	PVB over voltage	Check the serial connection of the PV array. Make sure that the open circuit voltage of the PV string is not higher than the maximum operating voltage of the inverter.
17	Ambient abnormal	<ol style="list-style-type: none"><li>1. Check the ventilation and the ambient temperature at the installation point.</li><li>2. If the ventilation is poor or the ambient temperature is too high, improve the ventilation and heat dissipation.</li><li>3. Contact SLA service if both the ventilation and the ambient temperature are normal.</li></ol>
18	Residual Current Fault	<ol style="list-style-type: none"><li>1. If the problem occurs occasionally, it may be caused by a cable exception. The inverter will recover automatically after the problem is solved.</li><li>2. Check whether the impedance between the PV string and PE is too low if the problem occurs frequently or persists.</li></ol>
19	Hardware abnormal	Switch off the grid side AC circuit breaker, PV DC switch and battery circuit breaker, then switch them on 5 minutes later. Contact SLA service if the problem persists.
20	Precharge abnormal	Switch off the grid side AC circuit breaker, PV DC switch and battery circuit breaker, then switch them on 5 minutes later. Contact SLA service if the problem persists.
21	Insulation fault	<ol style="list-style-type: none"><li>1. Check whether the resistance of the PV string to PE exceeds 50kΩ. If no, check the short circuit point.</li><li>2. Check whether the PE cable is connected correctly.</li><li>3. If the resistance is lower on rainy days, please reset the ISO.</li></ol>
22	AC side relay abnormal	Switch off the grid side AC circuit breaker, PV DC switch and battery circuit breaker, then switch them on 5 minutes later. Contact SLA service if the problem persists.
23	PVA Reverse Connection Fault	Check whether the PV strings are connected reversely.
24	PVB Reverse Connection Fault	Check whether the PV strings are connected reversely.

---

25	Hardware DC Bus Over Voltage	Switch off the grid side AC circuit breaker, PV DC switch and battery circuit breaker, then switch them on 5 minutes later. Contact SLA service if the problem persists.
26	Hardware Battery Over Voltage	Switch off the grid side AC circuit breaker, PV DC switch and battery circuit breaker, then switch them on 5 minutes later. Contact SLA service if the problem persists.
27	Grid 10 minutes Over Voltage	<ol style="list-style-type: none"> <li>1. If the problem occurs occasionally, the distribution grid may be abnormal temporarily. The inverter will recover automatically after detecting that the distribution grid is normal.</li> <li>2. If the problem occurs frequently, check whether the grid frequency is within the permissible range.</li> <li>3. Contact the local power distribution company if the grid voltage exceeds the permissible range.</li> <li>4. Modify the overvoltage protection threshold or disable the overvoltage protection function after obtaining the consent of the local power distribution company if the grid voltage is within the permissible range.</li> </ol>
28	EPS(Off-grid) Overload Fault	<ol style="list-style-type: none"> <li>1. If the problem occurs occasionally, the EPS load may be abnormal temporarily. The inverter will recover automatically after few minutes.</li> <li>2. If the problem occurs frequently, check whether the EPS load is within the permissible range.</li> <li>3. Contact the SLA service if the problem persists.</li> </ol>
29	Fan Fault	Switch off the grid side AC circuit breaker, PV DC switch and battery circuit breaker, then switch them on 5 minutes later. Contact SLA service if the problem persists.
30	DC Relay Fault	Switch off the grid side AC circuit breaker, PV DC switch and battery circuit breaker, then switch them on 5 minutes later. Contact SLA service if the problem persists.
31	Power Meter Communication Fault	<ol style="list-style-type: none"> <li>1. Check the Meter is working properly and the cable connection from Power meter to inverter is normal.</li> <li>2. Switch off the grid side AC circuit breaker, PV DC switch and battery circuit breaker, then switch them on 5 minutes later.</li> <li>3. Contact SLA service if the problem persists.</li> </ol>
32	N-PE relay fault	Switch and Battery switch, then connect them 5 minutes later. Contact the dealer or the after-sales service if the problem persists.

## 12 Packaging, Transportation, Storage

- The system cabinet is packed in cardboard packaging and the internal PE packaging bag is moisture-proof and waterproof.
- Use EPE pearl cotton foam pad in the middle to prevent damage to the system during handling and transportation.
- Transportation must comply with UN3481's dangerous goods transportation and local laws and regulations.
- The system is heavy and must use the mechanical handling.
- Transportation temperature:  $-10\text{ }^{\circ}\text{C} \sim 40\text{ }^{\circ}\text{C}$ .
- The equipment and packaging should not be transported in the open air.
  
- Storage temperature:
  - ◆  $-20\text{ }^{\circ}\text{C} \sim 35\text{ }^{\circ}\text{C}$ , 12month;
  - ◆  $-20\text{ }^{\circ}\text{C} \sim 45\text{ }^{\circ}\text{C}$ , 3month;
  - ◆  $-20\text{ }^{\circ}\text{C} \sim 55\text{ }^{\circ}\text{C}$ , 1month;(The SOC before storage is kept in the range of 30% to 60%)
- Storage humidity: 0%~95%RH (No condensation)
- The storage room should be kept ventilated, the room should be clean and dry, and it should be protected from dust and moisture.
- It is recommended to charge and discharge the system after every 3 month to save deep discharge the system
- In storage room the direct sunlight should not exposed to the store equipments.

## Annex 1: Inverter Parameter Table

Technical Data	SLA-HB-S1-6kW1P	SLA-HB-S1-5kW1P	SLA-HB-S1-3.8kW1P
<b>PV Input</b>			
Max.PV array power	3750 W/3750 W		
Max.DC voltage	600 V <sup>[3]</sup>		
Nominal DC operating voltage	360 V		
MPPT voltage range	100 V-540 V		
MPP voltage range for nominal power <sup>[5]</sup>	225 V-480 V	185 V-480 V	141 V-480 V
Start up voltage	120 V		
Max.input current(A/B)	15 A/15 A		
Max.short circuit current(A/B)	18 A/18 A		
No.of MPP tracks/String per MPP tracker	2/1		
<b>BAT Side</b>			
Battery voltage range	85V <sup>[4]</sup> - 400V		
Battery voltage range for nominal power	250 V-400 V	225 V-400 V	170 V-400 V
Recommended battery voltage	300 V		
Max.charge/discharge current <sup>[2]</sup>	25 A/25 A		
Communication interfaces	RS485/CAN		
Reverse connect protection	Yes		
<b>AC Grid Side(On-grid)</b>			
Nominal AC output power	6000 W <sup>[1]</sup>	5000 W <sup>[1]</sup>	3800 W
Max.Output Power	6000 W <sup>[1]</sup>	5000 W <sup>[1]</sup>	3800 W
Nominal Apparent Power Output to Utility Grid	6000 VA <sup>[1]</sup>	5000 VA <sup>[1]</sup>	3800 VA
Max. Apparent Power Output to Utility Grid	6000 VA <sup>[1]</sup>	5000 VA <sup>[1]</sup>	3800 VA
Nominal Apparent Power from Utility Grid	6000 VA	5000 VA	3800 VA
Max. Apparent Power from Utility Grid	6000 VA	6000 VA <sup>[6]</sup>	6000 VA <sup>[6]</sup>
Nominal grid voltage	230 V		
Grid Voltage Range	180 V-280 V		
Nominal grid frequency	50 Hz		
AC Grid Frequency Range	50 Hz±5 Hz		
Max. output AC current to Utility Grid	26.1 A	21.7 A	16.5 A
Rate output AC current to Utility Grid	26.1 A	21.7 A	16.5 A
Rated AC Current From Utility Grid	26.1 A	21.7 A	16.5 A
Max. AC Current From Utility Grid	26.1 A	26.1 A <sup>[6]</sup>	26.1 A <sup>[6]</sup>
Power factor	~1 (Adjustable from 0.8 leading to 0.8 lagging)		
I.TH D	<3%@Rated power		<5%@Rated power

**EPS Side**

Back-up Nominal Apparent Power	6000 VA	5000 VA	3800 VA
Nominal power	6000 W	5000 W	3800 W
Max. Output Apparent Power without Grid	7500 VA(<10 s)		
Max. Output Apparent Power with Grid	7500 VA(<10 s)		
Nominal output voltage	230 V		
Nominal output frequency	50 Hz		
Nominal Output Current	26.1 A	21.7 A	16.5 A
Max.output current	26.1 A	21.7 A	16.5 A
Max.output overcurrent protection	32.6 A(<10 s)		
Switching from Grid to backup Mode (switch over time)	<20 ms		
output THD	<5%@Linear Load		

**EFFICIENCY**

MPPT efficiency	99.9%	99.9%	99.9%
Euro efficiency	95.2%	95.2%	95.0%
Max. efficiency	96.8%	96.7%	96.5%
Battery charge/discharge efficiency	97.6%(PV-BAT)	97.6%(PV-BAT)	97.6%(PV-BAT)
	96.0%(BAT-AC)	96.0%(BAT-AC)	95.4%(BAT-AC)

**ENVIRONMENT LIMIT**

Ingress protection	IP65
Protection class	Class I
Pollution degree	PD3
Over voltage category	III (MAINS), II (DC)
Operating temperature range	-20°C~+60°C(derating at +45)
Max.operation altitude	<2000m
Humidity	0-95%
Cooling	Natural Ventilation
User Interface	LED,APP, Touch Button
Communication with BMS	CAN/RS485
Communication with Meter	RS485
Communication with Portal	WIFI
Typical noise emission	<40dB
Dimension (W*H*D)	800 mm*450 mm*160 mm
Weight	34 KG
Topology	Non-isolated
Self-consumption at Night	<25 W
DC Connector	MC4 (4~6 mm <sup>2</sup> )



AC Connector	Quick Plug
Storage Temperature	-40°C to +85°C
Standard warranty	5 years
<b>STANDARD</b>	
Safety	IEC/EN 62109-1&2, IEC 62477
EMC	IEC 61000-6-1, IEC 61000-6-3
Environment	IEC 60529, IEC 60068
Efficiency	IEC 61683
Certification	AS/NZS 4777.2

**Remark:**

- [1] The grid feed in power for VDE4105 is limited 4600VA.
- [2] Battery charging current is limited 25A and power is limited 6000W.
- [3] The MPPT board may be damaged if PV port exceeds this voltage, full power operation voltage should be less than 480V, and this range 480V-540V is for limited power operation.
- [4] Battery port boot voltage must be greater than 95V.
- [5] The power is 6000W according to the grid port.
- [6] The value will appear when the grid is charging battery and support EPS load.

## Annex 2: Battery Parameters

Mode	SLA-ESS-S1-5kWh	SLA-ESS-S1-10kWh	SLA-ESS-S1-15kWh	SLA-ESS-S1-20kWh	SLA-ESS-S1-30kWh
Component	Base+BMS + 1*Module	Base+BMS + 2*Module	Base+BMS +3*Module	2*(Base+BMS +2*Module)	2*(Base+BMS +3*Module)
Nominal Voltage	102.4 V	204. 8 V	307.2 V	204. 8 V	307.2 V
Maximum protection voltage	116.8 V	233.6 V	350.4 V	233.6 V	350.4 V
Maximum protection voltage	89.6 V	179.2 V	268.8 V	179.2 V	268.8 V
Number of Battery Modules	1	2	3	4	6
Rated Capacity	50 Ah	50 Ah	50 Ah	100 Ah	100 Ah
Total Energy	5.1 kWh	10.2 kWh	15.3 kWh	20.4 kWh	30.6 kWh
Nominal Power	2.56 kW	5.12 kW	7.68 kW	10.24 kW	15.36 kW
Maximum Charge/Discharge Current	30 A	30 A	30 A	50 A	50 A
Cycle life	6000 Cycles(@0.5C,90%DOD,25°C,60% SOH)				
Expected life time	10 Years(60%SOH)				
Operating Ambient Temperature	-20°C to 55°C				
Storage Temperature	-20°C to 45°C (3 months)				
	-20°C to 35°C(1 year)				
Humidity	0~95%				
Altitude	Below 2000 m				
Ingress Protection	IP65				
Switch on/off	Button*1 +Breaker*1	Button*1 +Breaker*1	Button*1 +Breaker*1	2* (Button*1 +Breaker*1)	2* (Button*1 +Breaker*1)
Certificate	CE ,IEC 62619,IEC 62040,IEC 60529,IEC 61000,UN 38.3				
Weight	69±4 kg	124±6 kg	179±8 kg	248±12 kg	358±16 kg
Dimension(W*H*D)	800±20*530 ±30*160±20 mm	800±20*840 ±30*160±20 mm	800±20*1150 ±30*160±20 mm	1600±20*840 ±30*160±20 mm	1600±20*1150 ±30*160±20 mm
Remark	1 Series			2 Series Parallel	

## Annex 3: System Parameter

Mode	SLA-BESS-S1-I5B10	SLA-BESS-S1-I5B15	SLA-BESS-S1-I5B20	SLA-BESS-S1-I5B30	SLA-BESS-S1-I3.8B5
Inverter	SLA-HB-S1-5kW1P	SLA-HB-S1-5kW1P	SLA-HB-S1-5kW1P	SLA-HB-S1-5kW1P	SLA-HB-S1-3.8kW1P
Battery	SLA-ESS-S1-10kWh	SLA-ESS-S1-15kWh	SLA-ESS-S1-20kWh	SLA-ESS-S1-30kWh	SLA-ESS-S1-5kWh
Remark	Annex 1 and Annex 2				



# Smart Lifestyle<sup>TM</sup>

A U S T R A L I A

---

- Ph: 1300 198 955 ■ ABN 54 652 113 561
- [info@smartlifestyleaustralia.com.au](mailto:info@smartlifestyleaustralia.com.au)
- [smartlifestyleaustralia.com.au](http://smartlifestyleaustralia.com.au)

Office Address

- Unit 1, 41 Anzac St, Greenacre, NSW 2190
- 16 Fastlane Road Truganina VIC 3029